

# NV Comfort™

## User guide

For version from 2.1.0.17

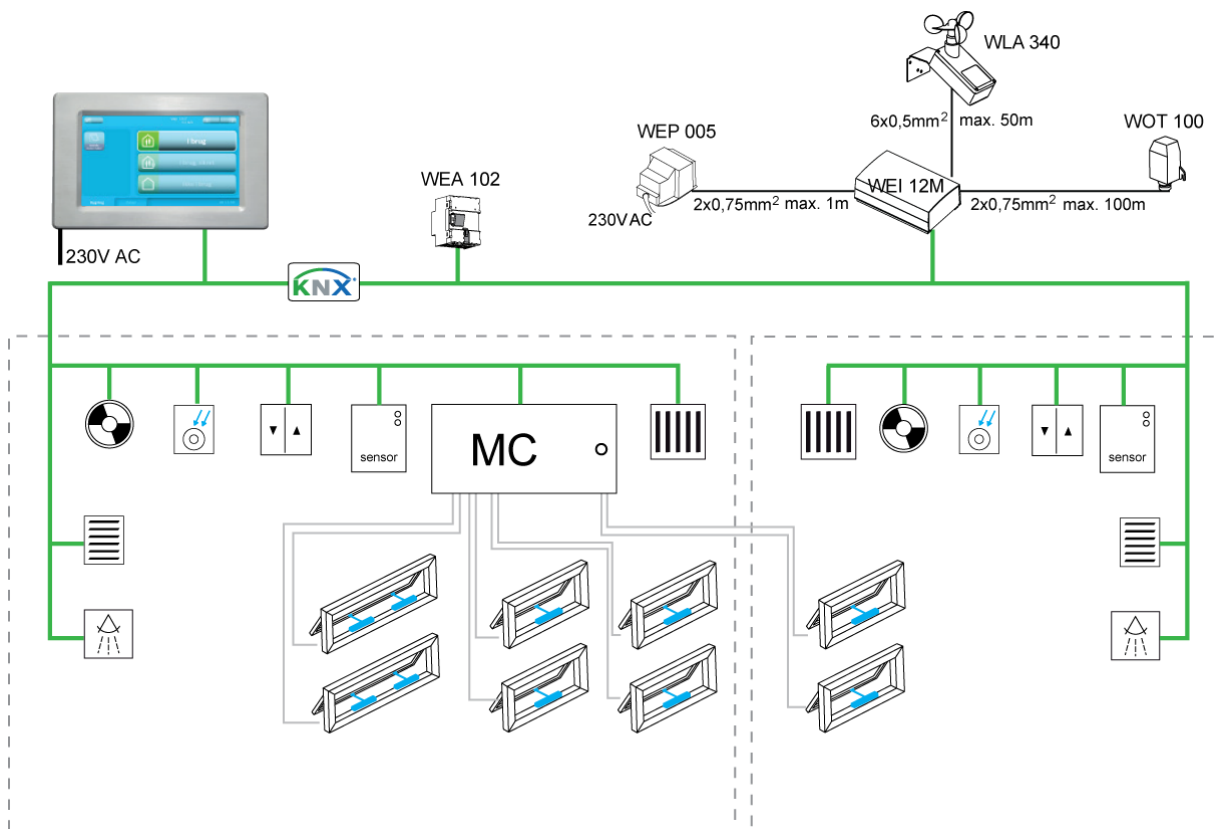

Save this user guide for the end-user.

Record any parameter changes in the tables in chapter 12.

|               |  |                          |
|---------------|--|--------------------------|
| DK:           | +45 4567 0300                                  | info.dk@windowmaster.com |
| DE:           | +49 (0) 5221 6940 -500 Vertrieb / -650 Technik | info@windowmaster.de     |
| UK:           | +44 (0) 1536 510990                            | info@windowmaster.co.uk  |
| CH:           | +41 (0) 62 289 22 22                           | info@windowmaster.ch     |
| Other markets | +45 4567 0300                                  | info@windowmaster.com    |

[www.windowmaster.com](http://www.windowmaster.com)

## Contents

|           |  |           |
|-----------|--|-----------|
| <b>1</b>  | <b>NV Comfort™</b> .....   | <b>4</b>  |
| <b>2</b>  | <b>Using NV Comfort™ for the first time</b> .....                                  | <b>5</b>  |
| 2.1       | General Settings .....   | 5         |
| 2.1.1     | Language settings .....  | 5         |
| 2.1.2     | General Settings .....   | 6         |
| 2.1.3     | Setting the date and time .....  | 6         |
| 2.1.4     | Room activation .....  | 7         |
| 2.2       | Building.....  | 8         |
| 2.2.1     | Building level .....   | 8         |
| 2.2.2     | Room level – Overview .....  | 9         |
| 2.2.3     | Room level.....  | 10        |
| 2.2.4     | Room level - details .....   | 11        |
| 2.2.5     | Override.....  | 12        |
| 2.2.6     | PIN .....  | 15        |
| <b>3</b>  | <b>NV Comfort™ Operating mode</b> .....  | <b>16</b> |
| <b>4</b>  | <b>Function description of Natural Ventilation</b> .....                           | <b>17</b> |
| <b>5</b>  | <b>Ventilation</b> .....   | <b>18</b> |
| 5.1       | Configuring the set-points .....   | 18        |
| 5.1.1     | Configuring set-points (summer).....   | 18        |
| 5.1.2     | Configuring set-points (winter) .....  | 19        |
| 5.1.3     | Requirement-controlled pulse ventilation .....                                     | 19        |
| 5.1.4     | Ventilation at defined times.....  | 19        |
| 5.1.5     | Configuration of the temperature set-point - switch between summer and winter..... | 20        |
| 5.1.6     | Configuring the temperature set-point for night cooling.....                       | 20        |
| 5.1.7     | Configuring the time period for night cooling .....                                | 21        |
| 5.1.8     | Configuring set-points.....  | 21        |
| <b>6</b>  | <b>Additional options for Natural Ventilation</b> .....                            | <b>23</b> |
| <b>7</b>  | <b>Heating control</b> .....   | <b>25</b> |
| <b>8</b>  | <b>Mechanical ventilation / hybrid Ventilation</b> .....                           | <b>26</b> |
| <b>9</b>  | <b>Sun screening</b> .....   | <b>27</b> |
| 9.1       | Configuration of safety set-points.....  | 28        |
| 9.2       | Configuring the strategy and the set-point.....                                    | 29        |
| 9.2.1     | Light strategy .....   | 29        |
| 9.2.2     | Energy strategy.....   | 30        |
| 9.2.3     | Energy including slat strategy .....   | 30        |
| <b>10</b> | <b>Lighting</b> .....  | <b>32</b> |
| <b>11</b> | <b>Parameter examples for Natural Ventilation</b> .....                            | <b>33</b> |
| 11.1      | Example #1 Ventilation in the summer.....  | 33        |

|           |   |           |
|-----------|---|-----------|
| 11.2      | Example #2 Ventilation throughout the year.....   | 34        |
| 11.3      | Example #3 Ventilation all year, including heating and mechanical ventilation control (hybrid ventilation).....                 | 36        |
| 11.4      | Example #4 Ventilation all year, including heating and mechanical ventilation control (hybrid ventilation) using ZoneVent™..... | 38        |
| 11.5      | Example #5 Ventilation and use of sun screening.....  | 39        |
| 11.5.1    | General settings for sun screening.....   | 39        |
| 11.5.2    | Example #5-1 Sun screening - light strategy.....  | 41        |
| 11.5.3    | Example #5-2 Sun screening - energy strategy.....   | 41        |
| 11.5.4    | Example #5-3 Sun screening - energy including slat strategy.....  | 41        |
| <b>12</b> | <b>Factory settings.....</b>  | <b>42</b> |
| 12.1      | Factory settings – basic settings (green screens).....  | 42        |
| 12.1.1    | General settings.....   | 42        |
| 12.1.2    | Room settings.....  | 43        |
| 12.2      | Factory settings – end-user level (blue screens).....   | 49        |
| <b>13</b> | <b>Maintenance.....</b>   | <b>50</b> |
| 13.1      | NVC KNX A00, touch screen.....  | 50        |
| 13.2      | WMX xxx-n, programmable chain actuator.....   | 50        |
| 13.3      | WEC xxM, MotorController.....   | 50        |
| 13.4      | WEW 02M KNX, complete weather station.....  | 50        |
| 13.5      | WET 112, temperature/CO <sub>2</sub> /humidity sensor.....  | 51        |
| 13.6      | WEL 100, lux sensor (outdoor).....  | 51        |
| 13.7      | WEO 1x0, PIR sensor.....  | 51        |
| 13.8      | WEK 1x0, keypads.....   | 51        |

# 1 NV Comfort™

NV Comfort™ comes in two versions: NV Comfort™ Standard and NV Comfort™ Plus.

This guide applies to both versions. At the beginning of each chapter, it will be indicated whether the function can be used in NV Comfort™ Plus.

The functions in NV Comfort™ can be implemented and activated independently of each other and as required so that the system can be adapted to the individual project at any time.

Depending on software card the NV Comfort™ can control up to four zones or up to eight zones.

An existing NV Comfort™ can be upgraded at any time to multiple zones and/or functionalities. Meaning it is possible to change from four zones to eight zones or to upgrade from a Standard version to a Plus version. Refer to the figure below for choice of solution.

|  | Functionality       |              |                                 |               |               |
|--|---------------------|--------------|---------------------------------|---------------|---------------|
|  | Natural Ventilation | Heat control | Mechanical ventilation (hybrid) | Light control | Sun screening |
| The features can be implemented and activated independently from each other and as needed, so the system at any time can be adapted to each project                                    |                     |              |                                 |               |               |
| <b>Standard 4 zones:</b><br>NV Comfort™ touch screen with adaptor<br>NV Comfort™ software card, 4 rooms/zones, Standard<br>NV Comfort™ basis pack (KNX-power supply + weather station) | ✓                   | ✓            |                                 |               |               |
| <b>Standard 8 zones:</b><br>NV Comfort™ touch screen with adaptor<br>NV Comfort™ software card, 8 rooms/zones, Standard<br>NV Comfort™ basis pack (KNX-power supply + weather station) | ✓                   | ✓            |                                 |               |               |
| <b>Plus 4 zones:</b><br>NV Comfort™ touch screen with adaptor<br>NV Comfort™ software card, 4 rooms/zones, Plus<br>NV Comfort™ basis pack (KNX-power supply + weather station)         | ✓                   | ✓            | ✓                               | ✓             | ✓             |
| <b>Plus 8 zones:</b><br>NV Comfort™ touch screen with adaptor<br>NV Comfort™ software card, 8 rooms/zones, Standard<br>NV Comfort™ basis pack (KNX-power supply + weather station)     | ✓                   | ✓            | ✓                               | ✓             | ✓             |

## 2 Using NV Comfort™ for the first time

NV Comfort™ comes with factory settings, i.e. English texts. The time has not yet been set and no zones have been defined. The basic settings must therefore be adapted to the current building and situation.

NV Comfort™ starts by displaying the screen images that the end-user will use (blue screens). These screens can be used to change the general settings.

The super-user has the option of going deeper into NV Comfort™ on the green screen shots and can therefore change the basic settings, parameters and set-points (green screens).

### 2.1 General Settings

#### 2.1.1 Language settings



To get to the basic settings menus (green screens), press the tool on the top left.

Access to the basic settings can be protected with a PIN code. See section 2.2.6.

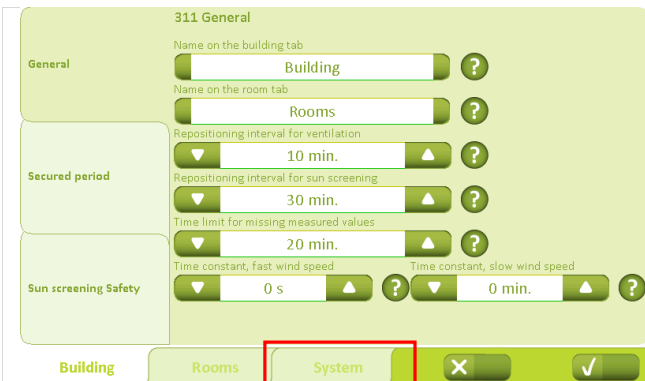

Use the "System" tab to choose between several different tabs for setting parameters.



The "General" tab can be used to configure: language, background illumination, the time after which the background illumination will go into sleep mode, the beep sound when the keys are used and the PIN code for super-user and end user respectively. It is also possible to calibrate the screen image.

When the settings have been selected, press "Accept" (the checkmark on the bottom right) to save the settings.

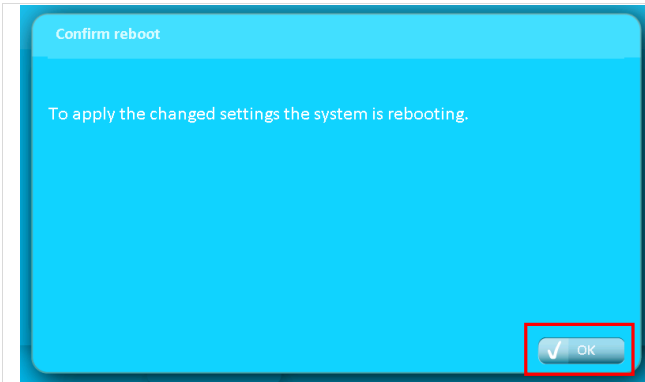

When/if the language is changed, the system must be rebooted for the change to take effect. Press “OK”.

All other settings are stored and implemented without rebooting the system.

### 2.1.2 General Settings

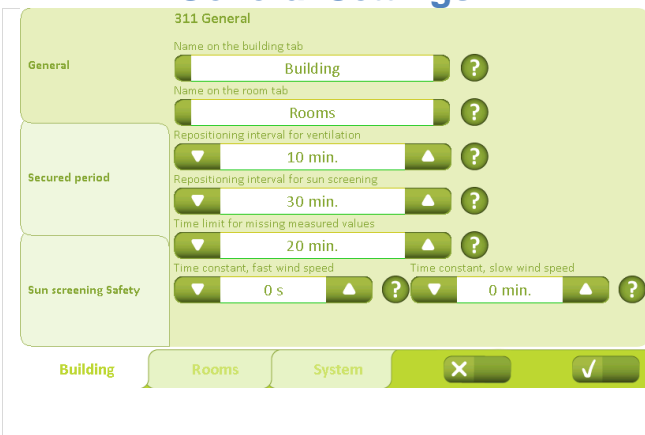

Under the “Building” – “General” tab, the building tab can be renamed and the time interval for the natural ventilation can be defined.

At regular intervals, the sensors transmit the measured values for CO<sub>2</sub>, temperature, RH and the measurement readings from the weather station. If the changes in the measurement values are less than the specified limits, NV Comfort™ only performs new calculations and adjustments at the intervals indicated here.

However, if the changes are larger than the specified limits, NV Comfort™ will make an adjustment instantly.

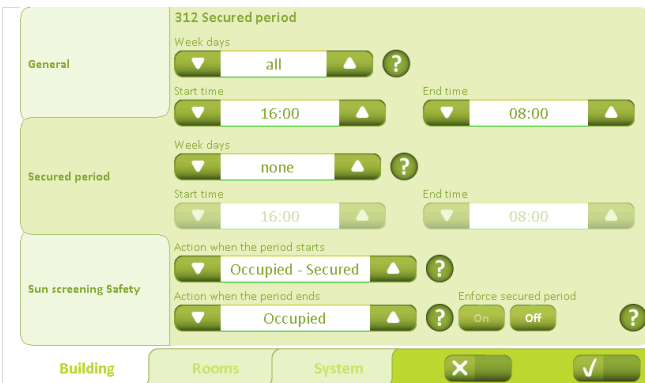

Under the “Building” – “Secured period” tab, secured periods can be defined using days and times.

If this feature is set, NV Comfort™ will automatically switch between the different operating modes at the required times.

Unless “Enforce secure period” is activated, the end user can override the operating mode on the blue screens. See section 2.2.1.

### 2.1.3 Setting the date and time

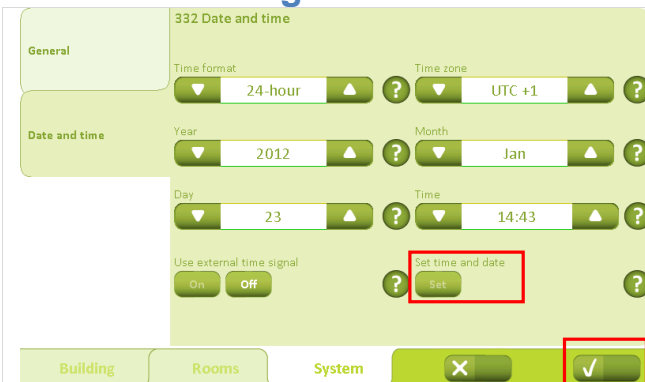

Use the “System” – “Date and time” tab to set the time format, time zone, year, month, date and time.

When the changes have been selected, press “Set” and then “Accept”.

An external time signal from WEA 11M can be connected and used. If an external time signal is used, this must be activated by pressing “On”.

## 2.1.4 Room activation

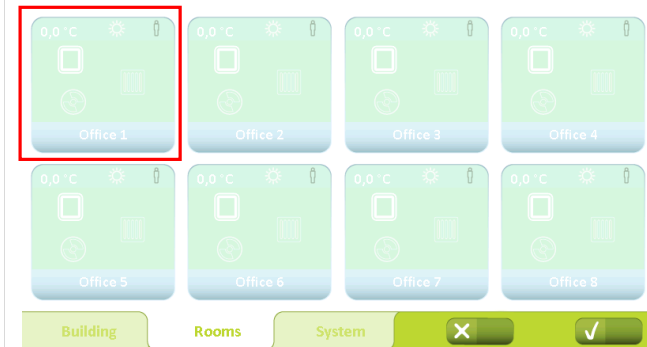

The rooms must be activated before the parameters can be set for the different rooms.

Press the “Room” tab to display the available rooms. Press a room to activate the room in question.



Press “On” in the room menu under the “Appearance” tab. The room is thereby activated.

The appearance (colour) and name of the room can be modified on this page.

Additionally, under “Names” the different window and/or sun screen groups can be renamed.

Furthermore, the sensors used/connected and the relevant controls must be activated. This is done by pressing “On” next to the respective sensors and controls.

Confirm the activation by pressing “Accept”. Refer to the relevant chapters for selecting sensors and controls.

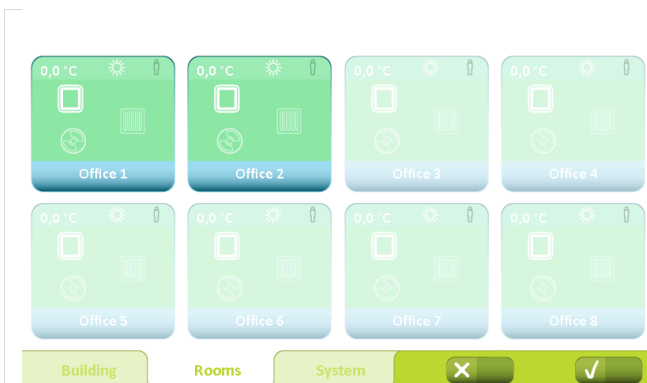

Repeat the process described above for all of the connected rooms.

The activated rooms are now displayed more clearly on the “Room” tab.

## 2.2 Building

### 2.2.1 Building level

On this screen the functions are common for all zones / rooms



#### 1 Building modes

- **In use:** The building is in normal use.
- **In use, secured:** The building is in use, but special restrictions on the opening of windows in individual rooms may be active (depends on the parameter settings).
- **Not in use:** There are no people in the building. Special restrictions on the opening of windows in individual rooms may be active. During the summer period, effective night-time ventilation may require that windows are kept open, even when there are no people in the building.

Switching between building modes occurs either by pressing on the screen or may be system-specified through connection of a burglar alarm. Parameters can be configured so that "In use" is only active outside a given time period.

#### 2 Keep windows closed

If this function is activated, windows will be closed and kept closed. The function remains active until it is deactivated.

#### 3 Discontinue automation

If this function is activated, the automatic control of the windows will be discontinued. However, the safety functions in the event of rain and strong wind will continue to be active. The function remains active until it is deactivated.

#### 4 Latest event

Information is provided here on the latest significant events:

- **KNX communications error** Problems communicating with the KNX bus.
- **All data missing** NV Comfort™ has not received all necessary data from the sensors (room sensors and weather station).
- **Weather data missing** NV Comfort™ has not received all weather data.
- **Room data missing** NV Comfort™ has not received data from the connected sensors.
- **Secured period started** See item 1.
- **Secure period ended** See item 1.
- **Closed, bad weather** The windows are closed and cannot be opened due to bad weather.
- **Closed, low indoor temperature** The windows are closed and cannot be opened due to low room temperature.
- **Everything OK** Information that everything is OK.

We recommend checking the installation if one of these events occurs repeatedly. Contact the installer if necessary.

#### 5 Weather information

Current wind speed and outdoor temperature are displayed here together with an icon for either rain, wind, cold, warm or unknown (no icon displayed)

#### 6 Activates menu for configuring parameters.

The access can be PIN code protected. See section 1.2.6 for further information.

#### 7 Activates the menu for information about:

- Weather data
- About (NV Comfort™ software version and copyright)
- Latest event
- Other (NV Comfort™ memory status)
- Remote log

#### 8 Explains the functions on this screen display.

#### 9 Switches to the overview of all the connected rooms.



## 2.2.2 Room level – Overview

This screen shows all the rooms that are connected to the NV Comfort™

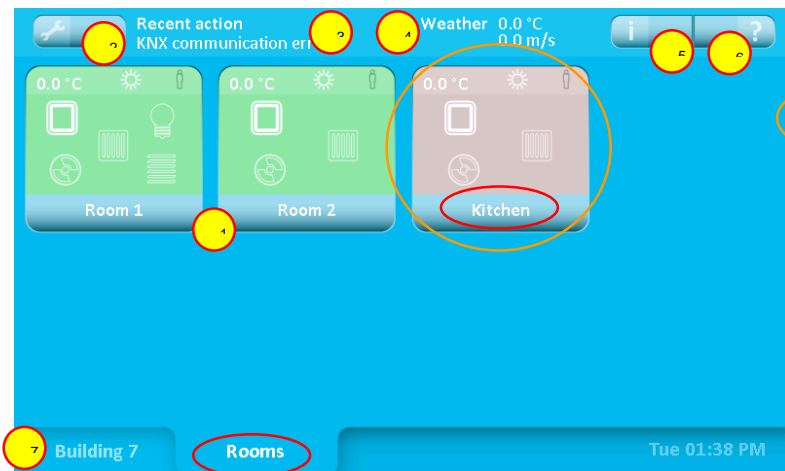

The colour of the room image can be changed in the parameter configuration. See section 2.1.4.

The names may change in the parameter configuration.

### 1 Pictures of the connected room

Overview image for each room.  
See section 2.2.3 for symbol description.

Press a particular room to activate the detailed menu for this room. See section 2.2.4.

### 2 Parameter configuration

Activates the menu for parameter configuration.  
This access can be locked with a PIN.

### 3 Latest event

See section 2.2.1.

### 4 Weather information

See section 2.2.1.

### 5 Information

Activates the menu for information about:

- Status of the rooms
- Latest event in the rooms
- Sun shade status

### 6 Explanation

Explains the functions on this screen display.

### 7 Show building

Switches to the overview image of the building.

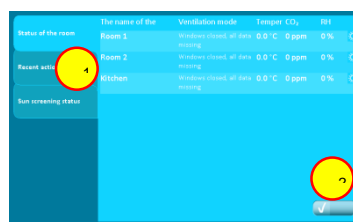

1 Switch between the tabs here

2 Return to the overview image showing all the rooms

## 2.2.3 Room level

Viewing the individual rooms - how much information is displayed depends on which sensors are connected

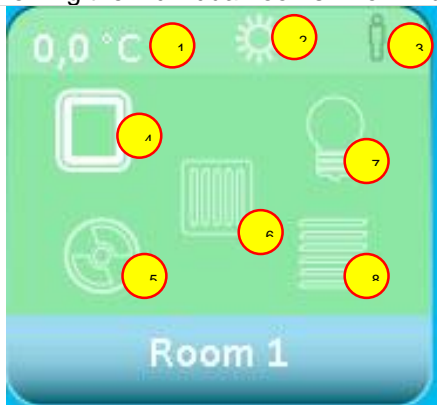

### 1 Room temperature

Current room temperature

### 2 Summer/winter mode

Switching between summer and winter mode occurs automatically based on the requirement for heating in the room or based on outdoor temperature.



Summer



Winter

### 3 Presence

The icon displayed depends on whether a CO<sub>2</sub> sensor, a PIR sensor or both are connected at the same time.



- low CO<sub>2</sub> level (CO<sub>2</sub> sensor)
- no people in the room (PIR detector)



- average CO<sub>2</sub> level (CO<sub>2</sub> sensor)
- people in the room (PIR detector)



- high CO<sub>2</sub> level (CO<sub>2</sub> sensor)
- many people in the room (both PIR detector and CO<sub>2</sub> sensor)

### 4 Status of the window

Only shown if the window in the room is connected.



Window open



Window closed



Window in secured mode

### 5 Mechanical ventilation (NV Comfort™ Plus)

Only shown if the mechanical ventilation in the room is connected.



Turned on



Turned off

### 6 Heating

Only displayed if there is heating control connected in the room.



Turned on



Turned off

### 7 Lighting (NV Comfort™ Plus)

Only displayed if there is PIR sensor connected in the room.



Turned on



Turned off

### 8 Sun screening (NV Comfort™ Plus)

Only displayed if there is a sun screening controller connected in the room.



Open



Closed

## 2.2.4 Room level - details

The room's functions can be controlled / overridden on this screen display and details are displayed for the room

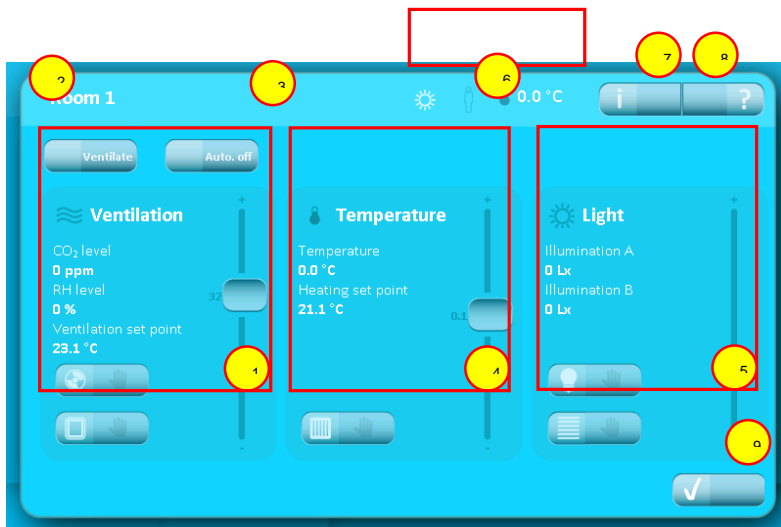

- 1 **Ventilation**  
See section 1.2.5 for further information.
- 2 **Ventilate**  
This button activates one ventilation pulse.  
The length of the airing is defined in the parameter setup.
- 3 **Auto. Off**  
This button turns off the automatic control of the ventilation and the light in the room.
- 4 **Temperature**  
See section 1.2.5 for further information.
- 5 **Light (NV Comfort™ Plus)**  
See section 1.2.5 for further information
- 6 **Room status**  
Shows the status of the room.  
See section 1.2.3 section 1 + 2 + 3 for further information.



the room temperature

- 7 **Information**  
Activates the menu for information about:
  - Indoor climate
  - Recent action

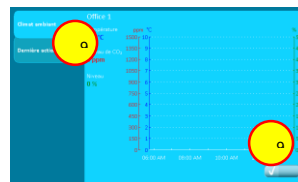

- 1 Switch between the tabs here
- 2 Return to the overview of the room

- 8 **Information**  
Explains the functions on this screenshot
- 9 **Show room level**  
Switch to the overview of the room level

## 2.2.5 Override

The mechanical ventilation can be overridden on these buttons

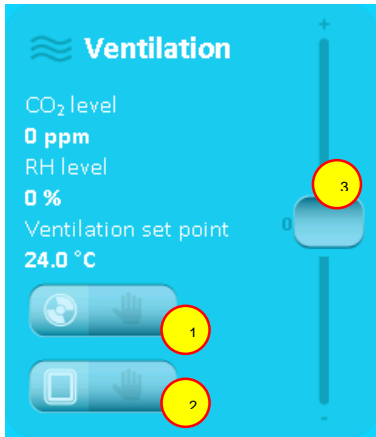

### 1 Mechanical ventilation - manual operation

Activates the menu for manual override of the mechanical ventilation

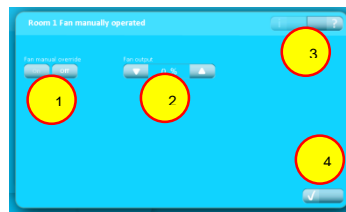

1 Mechanical ventilation manual override.  
Press OFF to return the system to automatic mode.

2 Mechanical ventilation control

3 Explains the functions on this screen display

4 Switch to the overview of the room

### 2 Window operation - manual

Activates the menu for manual override of the window.

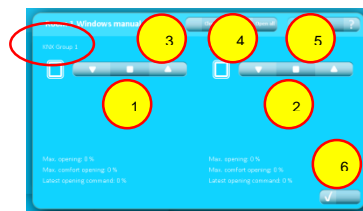

1 Group 1

2 Group 2

3 Close all

4 Open all

5 Explains the functions on this screen display

6 Switch to the overview of the room

The names can be changed in the parameter set up.

### 3 Mechanical ventilation set-point

Move the slider up for more ventilation  
Move the slider down for less ventilation

The automatic temperature control can be overridden on these buttons

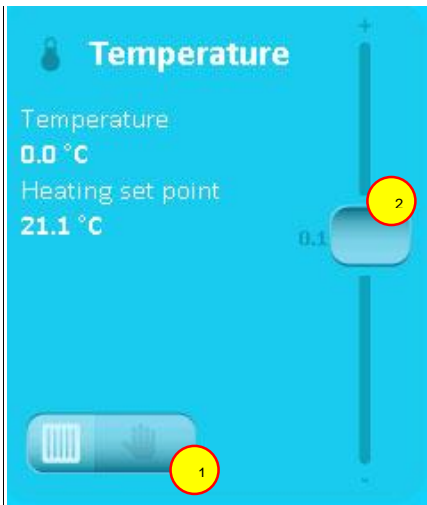

- 1 **Heating – manual control**  
Activates the menu for manual override of the heating control.

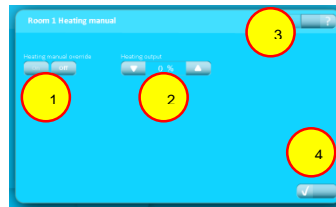

- 1 Heating manual override. Press OFF to return the system to automatic mode.
- 2 Heating control
- 3 Explains the functions on this screen display.
- 4 Return to the overview of the room

- 2 **Temperature set-point**  
Move the slider up to increase the set-point for temperature regulation.  
Move the slider down to lower the set-point for temperature regulation.  
  
A reduction of the set-point during the summer will produce more ventilation in order to achieve the lower temperature.  
During the heating period, an increase of temperature will entail an increase in energy consumption.

The automatic light control and sun screening can be overridden on this button (NV Comfort™ Plus)



- 1 **Lighting (Plus version)**  
Activates the menu for manual override of the lighting control.

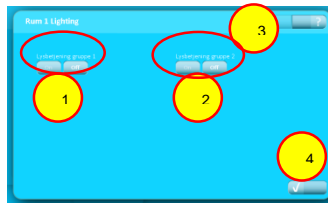

- 1 Group 1
- 2 Group 2
- 3 Explains the functions on this screen display.
- 4 Return to the overview of the room

The names may change in the parameter configuration.

- 2 **Sun screening (Plus version)**  
Activates the menu for manual override of sun screening.

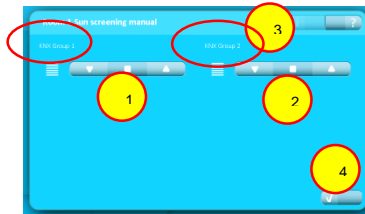

- 1 Group 1
- 2 Group 2
- 3 Explains the functions on this screen display.
- 4 Return to the overview of the room

The names may change in the parameter configuration.

## 2.2.6 PIN

### Entering a PIN

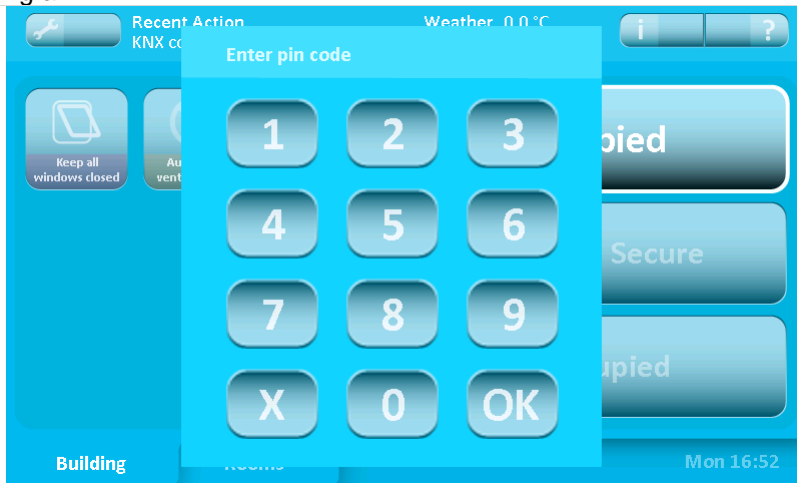

The system can be protected with a PIN at two levels:

1. For access to the system configuration
2. For access to all operation

If the system is PIN protected, the image above will appear when attempting to enter a secured level.

To access the level - enter the PIN and press "OK".

The system will automatically return to the protected mode after the specified time period.

PIN at levels 1 and 2 and the time period are set in the parameter configuration.

The PIN code protection and the predefined set of period are chosen in the parameter set up.

### 3 NV Comfort™ Operating mode



NV Comfort™ has three operating modes by which the system can be configured for the current conditions. See section 2.1.1.

Different window openings can be defined and configured in the different operating modes.

The different operating modes can be activated on the screen, via a timer program or via the KNX bus.



The window's maximum opening for the individual room and operating mode is configured under the "Windows" tab.

Two window openings can be defined for each room.

Two window groups should be used when the windows face in different directions or when roof and façade windows are combined in a zone.



## 4 Function description of Natural Ventilation

NV Comfort™ uses Natural Ventilation to ensure individual control of the indoor climate in each room. This occurs by all of the connected windows in both the roof and the façade opening and closing automatically and with millimetre precision, depending on the selected/configured ventilation requirement.

NV Comfort™ differentiates between summer and winter mode and uses the process below to regulate the indoor climate: NV Comfort™ changes between summer and winter mode automatically.

### Summer

Air exchange to cool and/or maintain a good indoor climate

- Temperature-controlled operation
- The room's CO<sub>2</sub> and RH levels affect the temperature setting

### Winter

Air exchange as required or configured to maintain a good indoor climate

- Requirement-controlled pulse ventilation – the opening, duration and frequency is requirement-controlled based on CO<sub>2</sub> and RH levels
- The ventilation function ensures the supply of fresh air at up to eight set times throughout the day.

NV Comfort™ uses the room's temperature to control the Natural Ventilation with the option also to control the room's CO<sub>2</sub> level and humidity. Based on the configured set-points, NV Comfort™ calculates a set-point containing all three variables.

Based on comparisons between the calculated set-points, weather data and the actual room data, NV Comfort™ calculates the current requirements for the Natural Ventilation.

### NV Comfort™ ventilation strategy

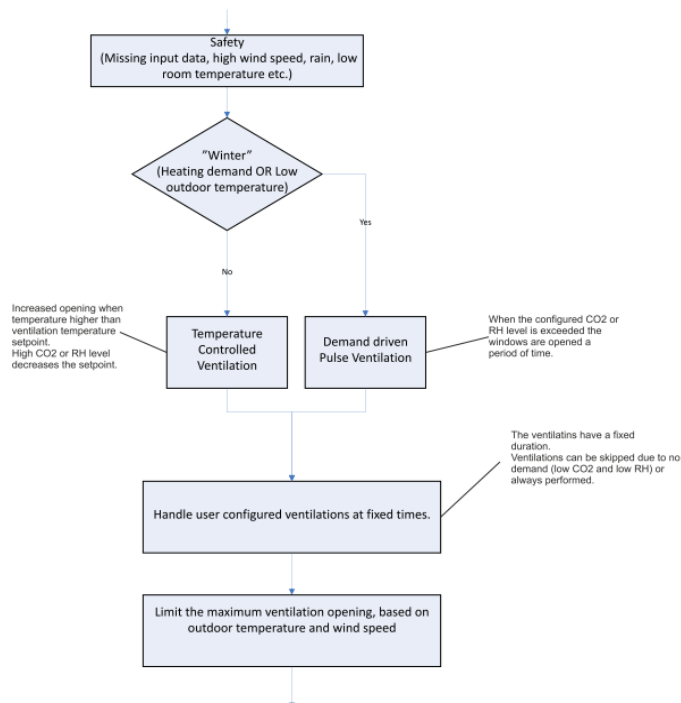

## 5 Ventilation

In order to use Natural Ventilation optimally, the factory default set-points can be modified. The set-points/limits must be set individually for each of the connected rooms and can thus be individually adapted.

### 5.1 Configuring the set-points

The following pages describe the various set-points and their effect on the system. Some set-points overlap in function. All items should be reviewed and the set-points adjusted as required or as recommended.

At the end of this guide there are examples of set-point configurations for different scenarios. See section 11.

#### 5.1.1 Configuring set-points (summer)

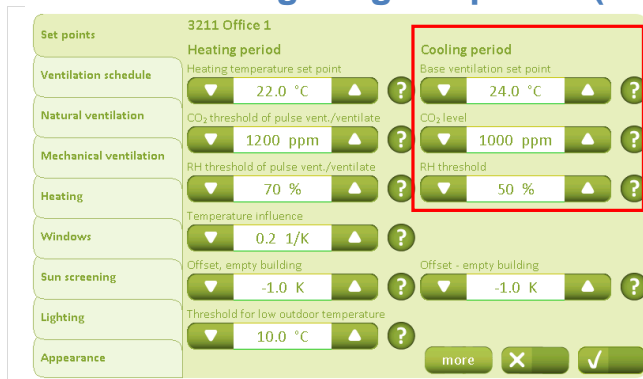

The set-points for summer operation are indicated under the “Set-points” tab and the “Cooling period” heading.

Based on the configured values, the system calculates the required set-point taking into account the current data.

The actual calculated set-point is always displayed on the current room overview (blue screens).

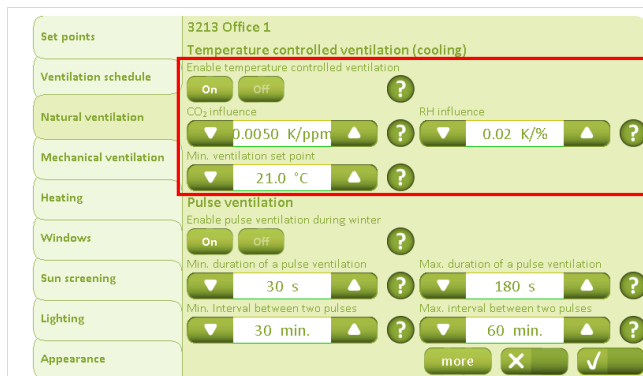

Enable whether the ventilation is to be temperature based or not. The effect of the CO<sub>2</sub> content and the relative humidity on the desired set-point to be calculated are configured under the “Natural Ventilation” tab, if the previously set limits are exceeded, the system reduces the temperature set-point in accordance with the settings.

For instance: current CO<sub>2</sub> content is 1,200 ppm and the relative humidity is 80%.

$$\text{CO}_2: (1,200 \text{ ppm} - 1,000 \text{ ppm}) \times 0.0050 \text{ K/ppm} = \underline{1\text{K}}$$

$$\text{RH}: (80\% - 50\%) \times 0.02\text{K/\%} = \underline{0.6\text{K}}$$

→ The temperature set-point is reduced by 1.6K.

The lower limit of the temperature set-point calculated by the system is also defined here. A lower set-point will not be permitted!

### 5.1.2 Configuring set-points (winter)

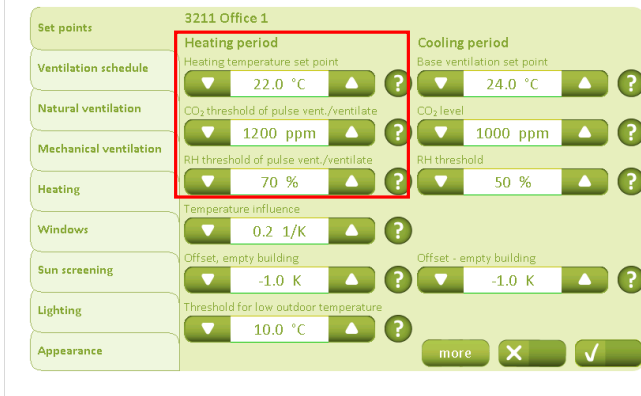

The set-points for winter operation are configured on the “Set-points” – “Heating period” tab.

The “Heating temperature set-point” defines not only the beginning of winter operation, but is also the set-point for any heating control. (Winter operation is used when the room temperature drops below the “Heating temperature set-point” or the outdoor temperature falls below the “Set-point for low outdoor temperature”).

The requirement-controlled pulse ventilation only occurs when the configured set-point is exceeded.

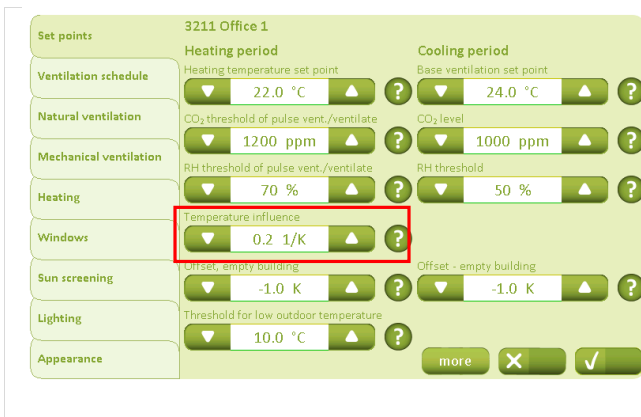

The “Temperature influence” value is used to determine whether pulse ventilation should also be used in winter when the temperature set-point, the relative humidity set-point or the CO<sub>2</sub> set-point is exceeded.

### 5.1.3 Requirement-controlled pulse ventilation

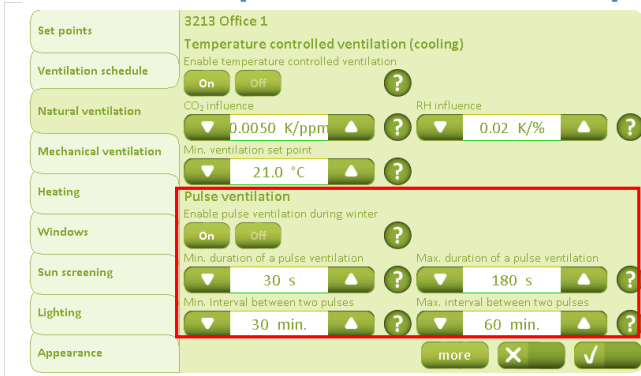

The “Natural Ventilation” tab is used to configure whether requirement-controlled pulse ventilation should be used.

The duration and the interval between the pulse ventilations are also configured here.

### 5.1.4 Ventilation at defined times



The time/length of the airing/ventilation and the time at which the ventilation should occur are configured on the “Ventilation times” tab.

You can choose whether this ventilation should “always” take place or only “as required” when the limit is exceeded.

The day on which ventilation should take place and the duration of the ventilation can also be determined.

Set if this ventilation is to take place summer or winter.

The duration set here is also the duration of the one-off ventilation set by the user. See section 2.2.4.

Press “More” for additional time options.

### 5.1.5 Configuration of the temperature set-point - switch between summer and winter

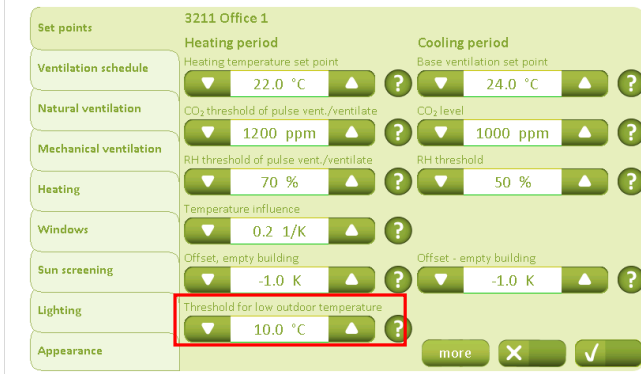

The “Set-points” tab is used to configure the “Threshold for low outdoor temperature”, which defines the temperature at which the system shifts between summer and winter operation.

(Winter operation is used when the room temperature drops below the “Heating temperature set-point” or the outdoor temperature falls below the “Set-point for low outdoor temperature”.

### 5.1.6 Configuring the temperature set-point for night cooling

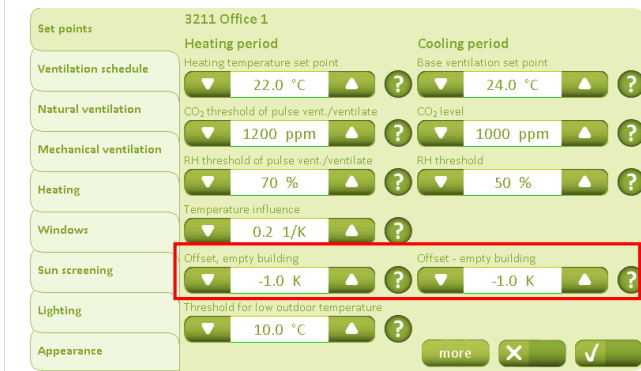

NV Comfort™ allows the lowering of the temperature set-point either to perform night cooling in summer or heat conservation in winter. The fields for temperature displacement “empty building” under the “Set-points” tab can be used for this purpose.

Changing the operating mode can be performed either on the screen, via the timer program or via the KNX bus – please refer to the respective section.

### 5.1.7 Configuring the time period for night cooling



The time period for the automatic change between operating modes is configured under the “Building” – “Secured period” tab.

In addition to the day of the week and the time period, the operating mode can also be configured.

Different time periods can be defined for weekdays and weekends.

If “Unoccupied” is selected, the set-point during this period is lowered in accordance with the previous setting.

### 5.1.8 Configuring set-points

Optimal configuration of the set-points is essential for Natural Ventilation. This also includes minimum room temperature and the window’s opening for rain and wind. These set-points can be individually set and are extremely important for ensuring that the system functions.

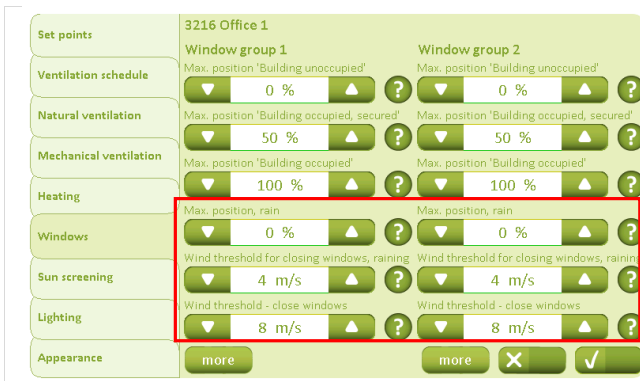

The maximum opening of the window in the event of rain is configured on the “Windows” tab.

The set-point for wind with or without rain must also be defined. If these limits are exceeded, the windows will be limited to “max position safety”.

Press “More” to bring up the screen image below for window groups 1 and 2 respectively.

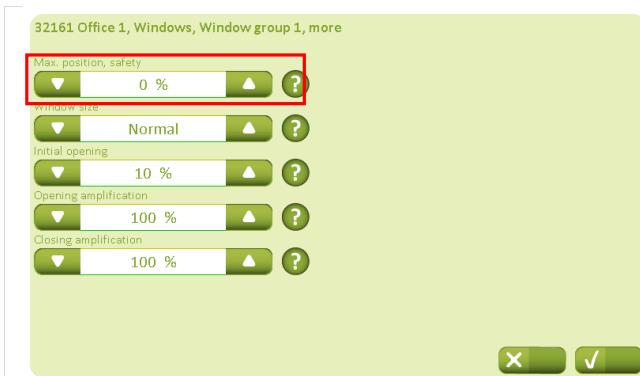

The values for “max. position, safety” define the maximum window opening permitted in the event of problems:

- No weather data
- No communication with KNX
- Bad weather
- Wind threshold exceeded
- Wind and rain threshold exceeded
- etc.



Under the “Natural Ventilation” tab, “Min. ventilation temperature set-point” defines the minimum ventilation set-point the system may use.

If the set-point is exceeded due to e.g. CO<sub>2</sub> and RH effect, the set-point will be limited by the value entered here.

It is recommended that it is kept at least 2K below the configured set-point, which is described in section 5.1.1.

Press “More” to bring up the screen image below.

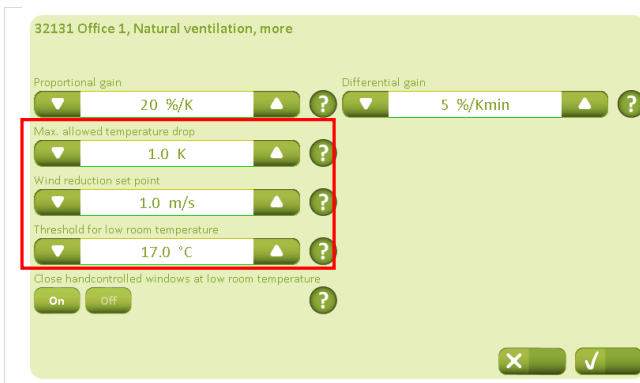

The maximum temperature drop compared to the temperature set-point defines when the windows must be closed. This is particularly important for ventilation with fixed times.

The “Wind reduction set-point” defines when the system begins to reduce the opening steps of the window opening in the event of high winds.

The “Threshold for low room temperature” is a guarantee that the windows will close if the room temperature is too low.

## 6 Additional options for Natural Ventilation



On the “Appearance” tab, the “Temperature sensor”, “CO<sub>2</sub> sensor” and “RH sensor” must be set to “On” in all rooms in order to control the Natural Ventilation.

Press “Names” to rename the window groups.

Press “More” to bring up the screen image below.



For Natural Ventilation to function, it is necessary to have a sufficient number of motorised windows in the building. For NV Comfort™ to be configured to switch optimally between ventilation and Comfort™ it is important that the windows used in a zone are correctly configured in relation to each other.

If the number of windows is different in the two window groups, the relationship between the two can be defined under the “Windows” – “More” tab. The relationship between group 1 and group 2 is defined here in terms of the number of windows and window size.

The indicated differences between the groups will be taken into account for the controls.

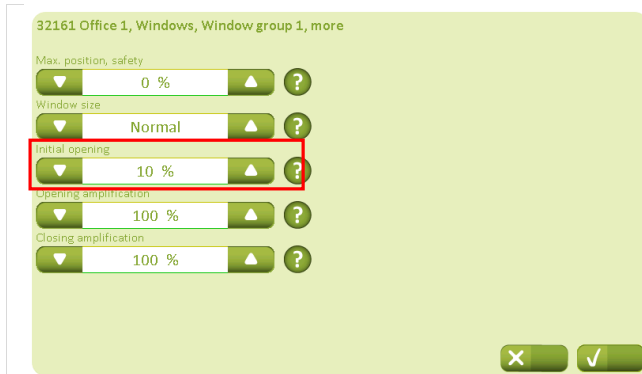

The value “Initial opening” defines the window’s opening, which must be performed at the first airing after the windows have been completely closed, e.g. to release the window’s gaskets from the frame.

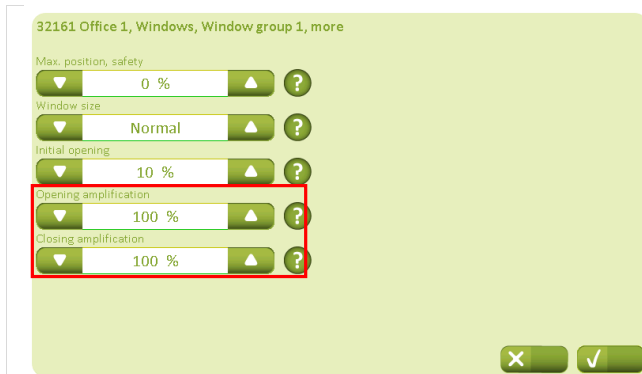

With the amplifications, it is possible to assign a greater significance to individual groups for ventilation purposes.

If the value is increased, the calculated window opening step is corrected with the configured value.

32191 Office 1, Appearance, Names

|   |                      |  |                      |
|---|----------------------|--|----------------------|
| <b>Window group 1</b>   |                      | <b>Window group 2</b>  |                      |
| Bus group 1 active  | Bus group 1 - name   | Bus group 2 active   | Bus group 2 - name   |
| <input type="button" value="On"/> <input type="button" value="Off"/> <input <="" td="" type="button" value="?"/> <td><input type="text"/></td> <td><input type="button" value="On"/> <input type="button" value="Off"/> <input <="" td="" type="button" value="?"/><td><input type="text"/></td></td> | <input type="text"/> | <input type="button" value="On"/> <input type="button" value="Off"/> <input <="" td="" type="button" value="?"/> <td><input type="text"/></td> | <input type="text"/> |

|   |                      |  |                      |
|---|----------------------|--|----------------------|
| <b>Sun screening Group 1</b>  |                      | <b>Sun screening Group 2</b>   |                      |
| Bus group 1 active  | Bus group 1 name     | Bus group 2 active   | Bus group 2 name     |
| <input type="button" value="On"/> <input type="button" value="Off"/> <input <="" td="" type="button" value="?"/> <td><input type="text"/></td> <td><input type="button" value="On"/> <input type="button" value="Off"/> <input <="" td="" type="button" value="?"/><td><input type="text"/></td></td> | <input type="text"/> | <input type="button" value="On"/> <input type="button" value="Off"/> <input <="" td="" type="button" value="?"/> <td><input type="text"/></td> | <input type="text"/> |

The names of the window groups can be changed.



## 7 Heating control

If the heating control is connected to NV Comfort™, the proportional gain and integration gain should be adapted to the individual rooms.



On the “Appearance” tab, “Heating control” must be set to “On” in all rooms in where heating control is required.

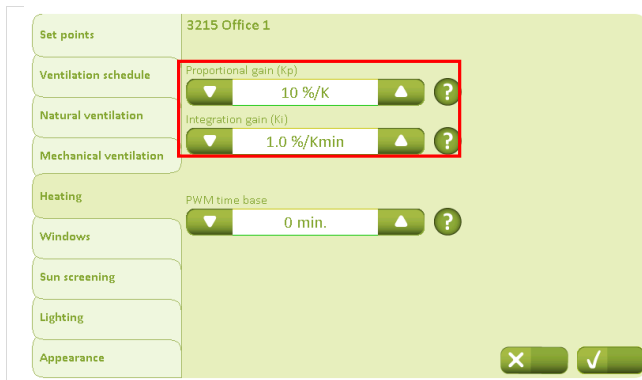

It is recommended not to set the proportional gain too high on the “Heating” tab, e.g. 50%/K, as this can result in instability/cyclic variation.

The integration gain must be adapted to the heat source. For example, it is recommended that it should be lower for under-floor heating than for radiators.

## 8 Mechanical ventilation / hybrid Ventilation

It is possible with NV Comfort™ Plus to connect mechanical ventilation to the system. By combining natural ventilation with mechanical ventilation, hybrid ventilation is achieved. The mechanical ventilation could be e.g. a ZoneVent™ (with or without heat recovery).

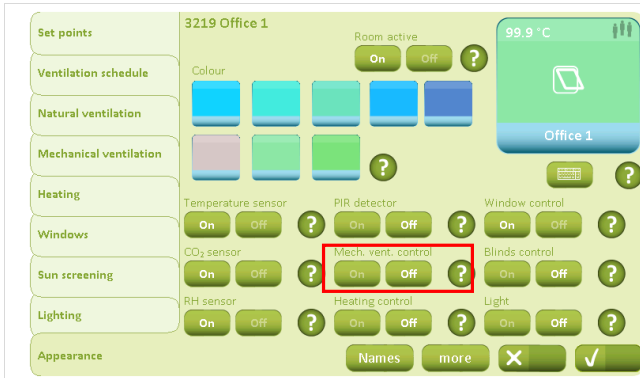

On the “Appearance” tab, “Mech. vent. control” must be set to “On” in all rooms in where control of mechanical ventilation is required.



The “Mechanical ventilation” tab is used to define the mechanical ventilation set-points for the heating and cooling periods respectively. The set-point for “Temperature offset for start” is based on the ventilation temperature set-point, which is defined under “Set-points”. See section 5.1.1.

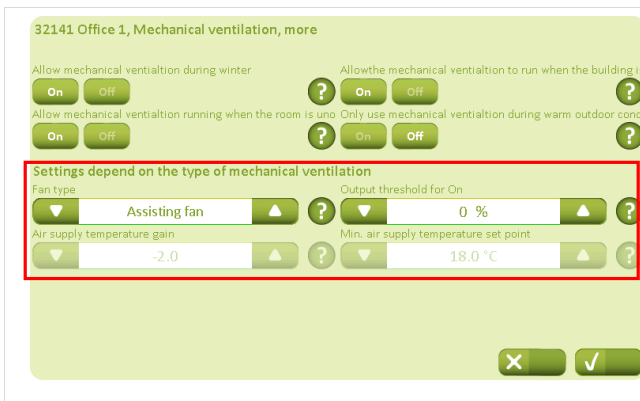

On the “Mechanical ventilation” “More” tab it is defined whether a ZoneVent™ or an assisting fan is used. It is not possible to use both an assisting fan and ZoneVent™!

To avoid cyclic variation in the mechanical ventilation, the “Output threshold for on” is defined here.

If a ZoneVent™ is used, the “air supply temperature reinforcement” and “minimum air supply temperature” must be adapted.

## 9 Sun screening

NV Comfort™ Plus allows control of sun screen products with or without slats.

The control of sun screen products takes place according to three different strategies.

- “Light strategy” – control of e.g. the blinds is based only on light measurements
- “Energy strategy” – control of e.g. the blinds is based on the exploitation of solar energy in winter and prevention of overheating in summer.
- “Energy including slats strategy” – control of e.g. the blinds is based on the exploitation of solar energy in winter and prevention of overheating in summer, and control of the slats for further optimisation of the solar energy.

It is also possible, independent of the strategy chosen, to configure sun screen products so that they provide a shield at night. Night-time is defined either by time or by light level.

Just as with control of the window actuators for ventilation, the sun screen products can also be divided into groups, e.g. for different directions or floors.



On the “Appearance” tab, “Blind control” must be set to “On” in all rooms if sun shade control is required.

Press “Names” to rename the sun screen groups.



The names of the sun screen groups can be changed.

## 9.1 Configuration of safety set-points

If sun screen products are connected to NV Comfort™ Plus, it is recommended that safety functions are configured for the sun screen product.

The safety functions can be configured either generally for the building or for the individual window groups. The safety settings for the building override the safety settings for the rooms, which can be regarded as a warning that the outdoor conditions (wind speeds and low temperature) are close to damaging the sun screen product. If the threshold limits for high winds or low outdoor temperature that are configured for the rooms are exceeded, it is still possible for the user to override the sun screen settings by manual control.

However, if the threshold limits for high winds or low outdoor temperature that are configured for the building are exceeded, it is not possible for the user to override the withdrawal of sun screen product by manual control.



The “Sun Screening Safety” tab under “Building” is used to configure the safety set-points generally for the building.

### Important!

The setting only influences the “Building\_SunScreeningSafety\_out” (KNX object no. 249).

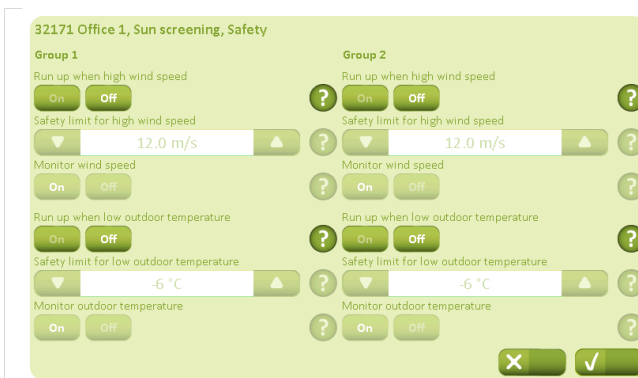

On the tab “Sun Screening” – “Room”, the safety set-points can be configured differently for the groups.

## 9.2 Configuring the strategy and the set-point

Regardless of the strategy selected for control of the sun screen products, a number of set-points have to be considered in order to achieve optimal performance.



The required control strategy is selected on the “Sun screening” tab under “Room”.

### 9.2.1 Light strategy

If simple control of the sun screen product is selected, where control of the sun screen product is only performed on the basis of light levels, the following parameters must be configured.



The “Sun screening” tab is used to define how the sun screen products are to be controlled in the different operating forms.

“Night period” must be defined if “Screen due to night” is selected (see next image).

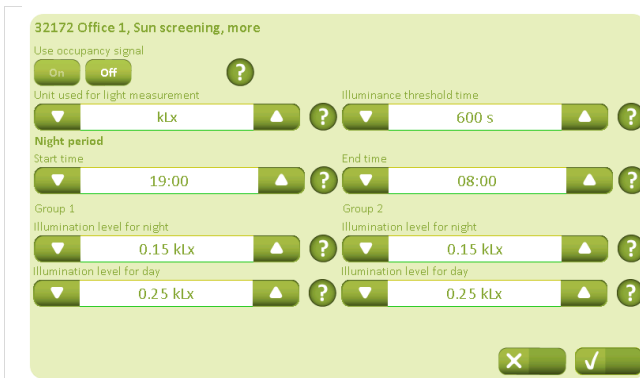

The “Night period” must be defined on the tab “Sun screening” – “More”, either with fixed times or by defining lighting levels. If “Screen due to night” is activated, the sun screen product will be deployed during the defined night period.

The time configuration overrides the “Lighting level”. If the “Lighting levels” are set to 0, this function is deactivated and the “Night period” is only defined by a period of time.

When defining the light level, the measurement unit is configured to the same unit used by the light meter

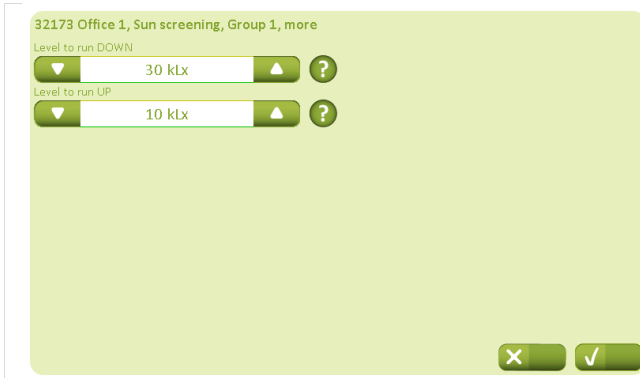

Lighting values for when the sun screen product can be deployed / withdrawn must be defined on the tab “Sun screen” – “More”.

In order to avoid cyclical variation of the sun screen product, the two levels should not be too close together.

### 9.2.2 Energy strategy

If it is decided to control the sun screen according to an energy strategy, in addition to the parameters whose configuration is described in section 9.2.1, the parameters must be configured according to how the solar energy affects the building.

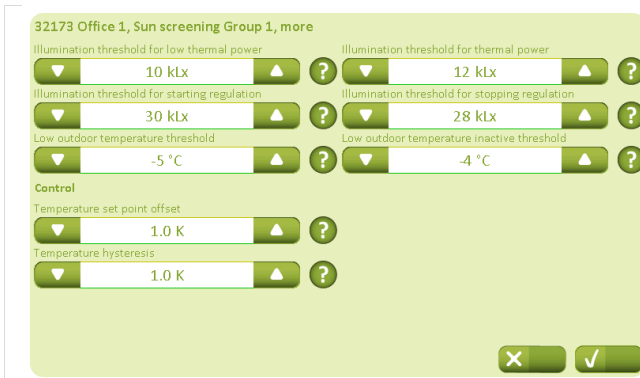

The temperature and lighting set-points must be defined on the tab “Sun screening” – “More” based on when light levels and outdoor temperature contribute positively or negatively to the building’s room temperature.

The “Low outdoor temperature threshold” should not be set lower than the “Safety level for low outdoor temperature”, as it will then be overridden (section 9.1).

### 9.2.3 Energy including slat strategy

If it is decided to control the sun screen according to an “Energy including slats” strategy, in addition to the parameters whose configuration is described in section 9.2.2, the parameters must be configured according to how the solar energy affects the building.

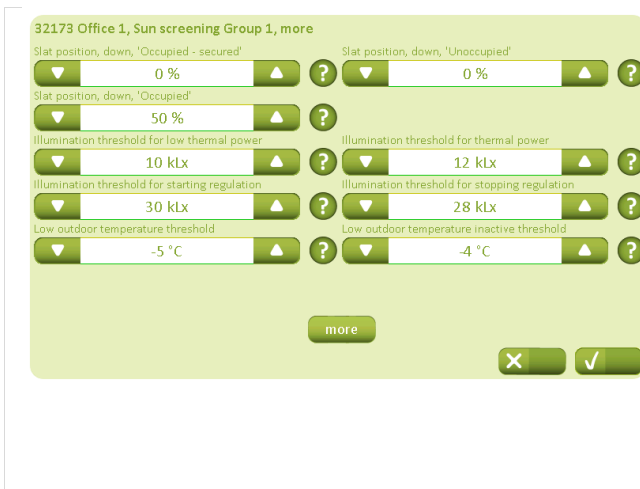

The slat position (horizontal or vertical) when the slats are deployed in the different operating modes must be defined under the tab “Sun screening” – “More”.

- 0% = vertical slats
- 50% = horizontal slats

It must be defined here when the temperature and lighting set-points contribute positively or negatively to the building’s room temperature.

In order to avoid cyclical variation, it is recommended that the set-points should not be too close together.

The “Low outdoor temperature threshold” should not be set lower than the “Safety level for low outdoor temperature”, as it will then be overridden (section 9.1).

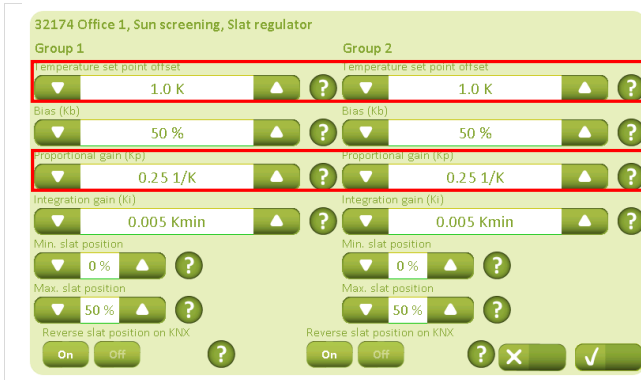

The tilting of the slats must be configured under the tab “Sun screening” – “More”. The tilting is based on temperature measurements in the room.

In order to avoid cyclical variation of the slats, it is recommended that the set-points must not be configured too low for “Temperature set-point offset” and “Proportional gain” respectively.

## 10 Lighting

It is possible to connect lighting control to NV Comfort™ Plus. The use of lighting control is selected based on an energy perspective, since the primary reason for the selection of lighting control is the desire to conserve energy. It is only possible to configure the turning off of the lights when the room is vacated. A conscious action by the user is required to turn on the lights. The feature requires that a PIR sensor must be connected to the system.



On the “Appearance” tab, the “Lighting control” and “PIR sensor” must be set to “On” in all rooms in where lighting control is required.



On the “Lighting control” tab, the “Send off signal” must be set to “On” in all rooms if lighting control is required.

The “Occupancy time” can be configured as required.



# 11 Parameter examples for Natural Ventilation

NV Comfort™ is supplied with standard parameters. Depending on where and for what NV Comfort™ is to be used, it may be necessary to make parameter changes to achieve optimum utilisation of the system.

This chapter describes various examples with an explanation of what parameters can/must be changed.

## 11.1 Example #1 Ventilation in the summer

NV Comfort™ is installed to improve the indoor climate in the summer.

- In the summer: temperature control without night cooling
- In the winter: manual ventilation
- For ventilation, there is no difference between day and night
- The wind and rain safety functions are active (section 5.1.8)
- The indoor climate is controlled according to room temperature and outdoor temperature

The following parameters must be changed:

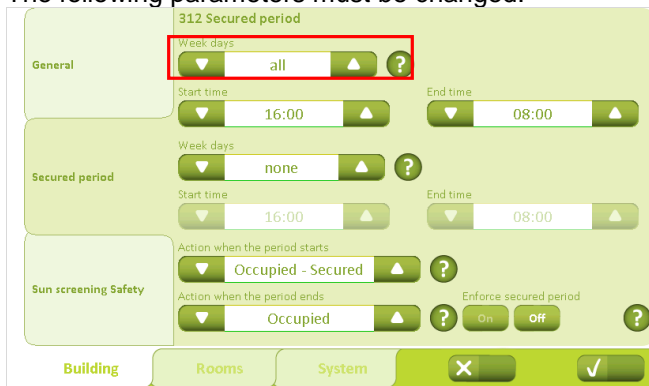

“Week days” must be changed from “all” to “none” under operating modes. In other words, there are no times where there is no ventilation if this is necessary according to the temperature.

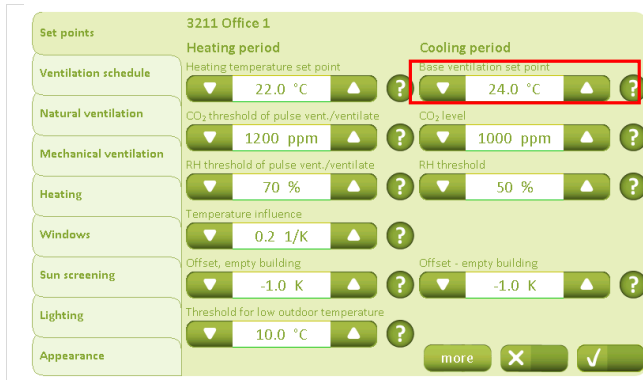

In the “Cooling period”, the “Basic ventilation set-point” can be defined for the each room as required.

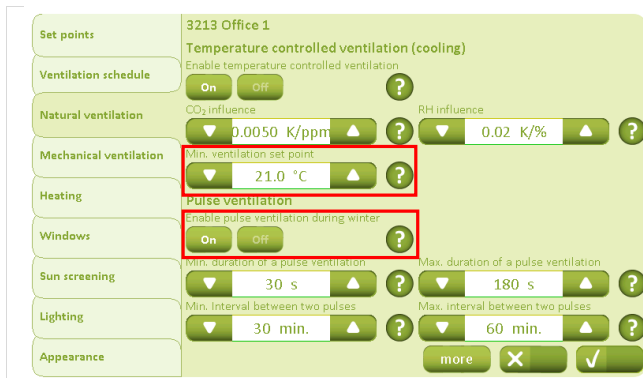

The “Minimal ventilation set-point” can be configured as required. Be aware that it must be at least 2K higher than the “Set-point for low room temperature” (screen image under “More”), as this could otherwise cause cyclical variation.

The “Pulse ventilation” must be set to Off. It should not be possible to have pulse ventilation in winter, as temperature control is only required in summer.

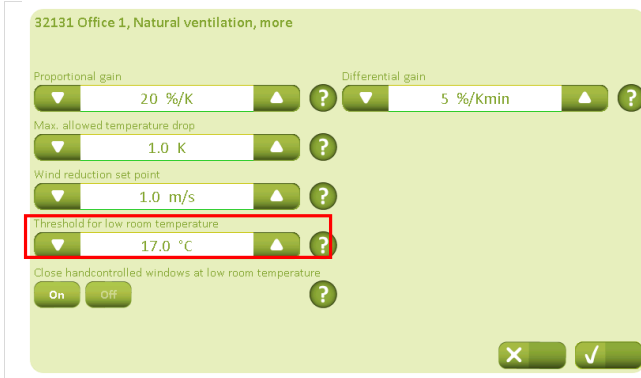

The “Threshold for low room temperature” must be at least 2K lower than the “Minimal ventilation set-point” that has just been set.



Since only one temperature-dependent ventilation is required, “CO<sub>2</sub> sensor”, “RH sensor”, “PIR sensor”, “ventilation control” and “heating control” must be set to “Off”.

## 11.2 Example #2 Ventilation throughout the year

NV Comfort™ is installed to improve the indoor climate throughout the year.

- In the winter: Pulse ventilation
- In the summer: Temperature control with night cooling
- The wind and rain safety functions are active (section 5.1.8)
- The indoor climate is controlled according to: room temperature, outdoor temperature, relative humidity, CO<sub>2</sub> content, rain and wind.

The following parameters must be changed:

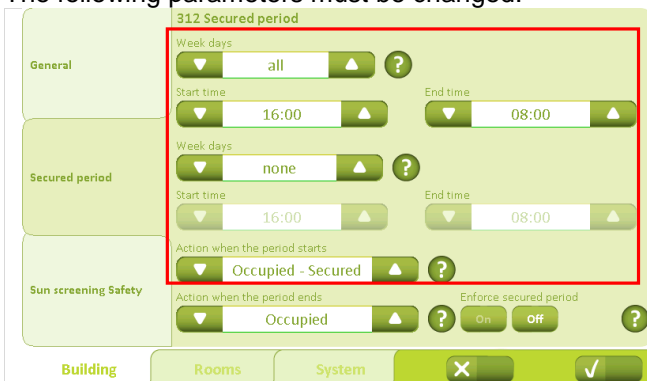

The time periods for the different operating modes must be configured here. For example, two different times can be configured: one for working days and one for weekends.

The building condition at the start of the period must be changed from “Occupied - secured” to “Unoccupied”.

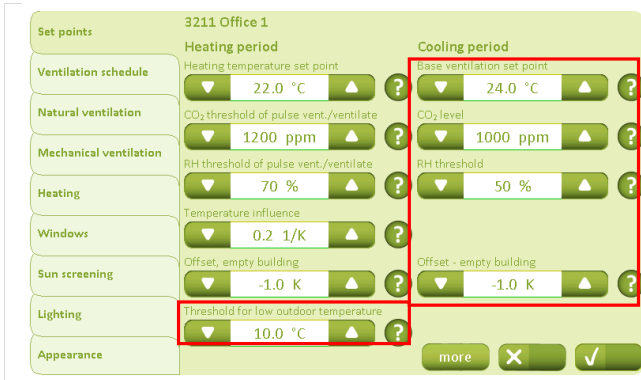

Under “Heating period”, the set-points for the winter mode can be configured.

Under the “Threshold for low outdoor temperature” sep-point it can be configured when to change between summer and winter mode.

Under “Cooling period”, the set-points for the summer mode can be configured for ventilation temperature, CO<sub>2</sub> level and the relative humidity.

“Offset – empty building” must be adapted to achieve the required sinking of temperature by “empty building”, e.g. to achieve a night cooling.



The window parameters for the different rooms can be adapted here.

For example, if “Window group 1” is on the ground floor and “Window group 2” is on the first floor, the maximum window opening can be changed so that ventilation is performed with “Window group 2” (the higher windows), even when the building is not in use.



Since the ventilation is to be performed according to temperature, CO<sub>2</sub> and humidity, these sensors are set to “On”, whereas the “PIR sensor”, “Mech. vent. control”, “Heating control”, “Blinds control” and “Light control” must be set to “Off”.

### 11.3 Example #3 Ventilation all year, including heating and mechanical ventilation control (hybrid ventilation)

NV Comfort™ is installed to improve the indoor climate throughout the year.

- In the summer: Temperature control with night cooling
- In the winter: Pulse ventilation and heating and ventilation control
- The wind and rain safety functions are active (section 5.1.8)
- The indoor climate is controlled according to: room temperature, outdoor temperature, relative humidity, CO<sub>2</sub> content, rain and wind.

The following parameters must be changed:



The time periods for the different operating modes must be configured here. For example, two different times can be defined: one for working days and one for weekends.

The building condition at the start of the period must be changed from “Occupied - Secure” to “Unoccupied”

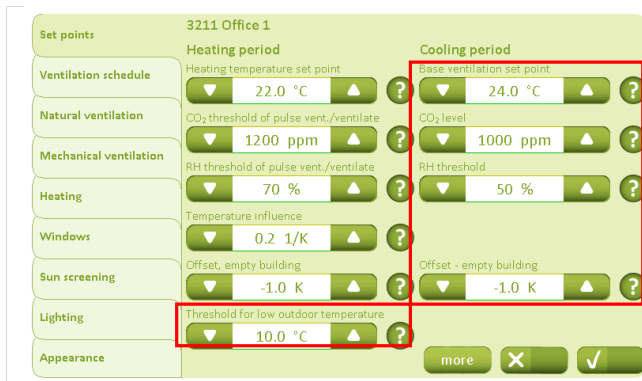

Under “Heating period”, the set-points for the winter mode can be configured.

Under the “Threshold for low outdoor temperature” sep-point it can be configured when to change between summer and winter mode.

Under “Cooling period”, the set-points for the summer mode can be configured for ventilation temperature, CO<sub>2</sub> level and the relative humidity.

“Offset – empty building” must be adapted to achieve the required sinking of temperature by “empty building”, e.g. to achieve a night cooling.



Parameters for temperature, CO<sub>2</sub> and RH effect on the mechanical ventilation can be adjusted as required.

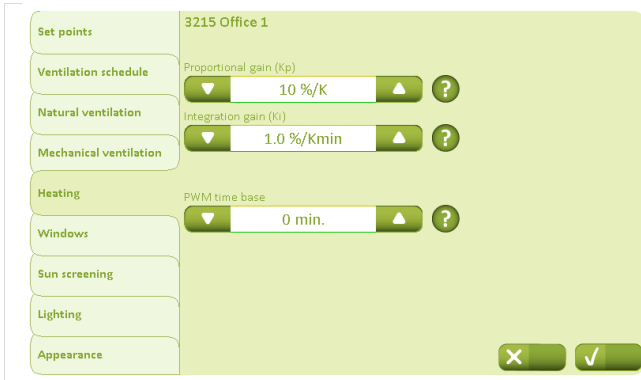

Parameters for heating control can be adjusted as required.



The window parameters for the different rooms can be adapted.

For example, if "Window group 1" is on the ground floor and "Window group 2" is on the first floor, the maximum window opening can be changed so that ventilation is performed with "Window group 2" (the higher windows), even when the building is not in use.



Since the ventilation is to be carried out according to the temperature, CO<sub>2</sub> and humidity, the PIR sensor, Blinds control, and light control must be set to Off.

## 11.4 Example #4 Ventilation all year, including heating and mechanical ventilation control (hybrid ventilation) using ZoneVent™

NV Comfort™ is installed as a part of a hybrid ventilation solution (incl. mechanical ventilation) to improve the indoor climate throughout the year.

- In the summer: Temperature control with night cooling.
- In the winter Pulse ventilation and heating and ventilation control
- Use of the ZoneVent™ (mechanical ventilators)
- The wind and rain safety functions are active (section 5.1.8)
- The indoor climate is controlled according to: room temperature, outdoor temperature, relative humidity, CO<sub>2</sub>, rain and wind.

To achieve the situation described in example 4, perform the parameter changes described in example 11.3. However, the use of ZoneVent™ must be activated and it must be decided whether a presence signal is to be used.

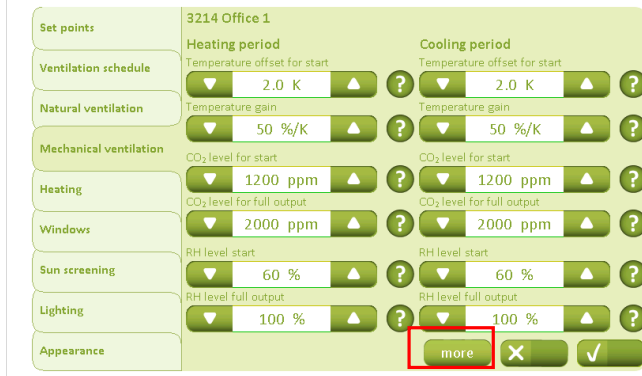

The mechanical ventilation set-points for the heating and cooling period must be defined. The set-point for “Temperature offset for start” is based on the ventilation temperature set-point, which is defined under “Set-points”.

Click on “More” to activate ZoneVent™.

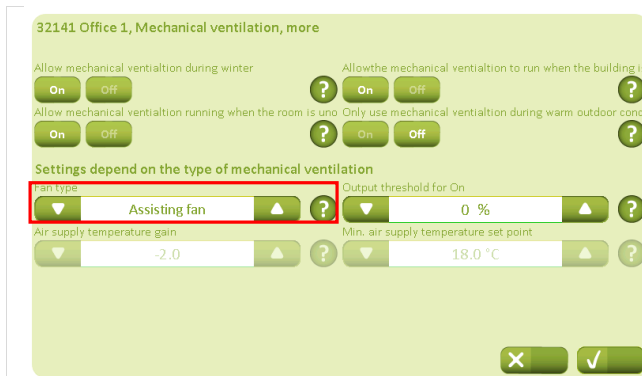

Under the “Fan type” “ZoneVent™” is selected.

The “Air supply temperature gain” and “Minimum air supply temperature set-point” must be adjusted.

NV Comfort™ cannot control an assisting fan and ZoneVent™ in the same room.

## 11.5 Example #5 Ventilation and use of sun screening

NV Comfort™ is installed to improve the indoor climate throughout the year and control sun screening.

- In the summer: Temperature control with night cooling
- In the winter: Pulse ventilation and heating and ventilation control
- Use of sun screen product
- The wind and rain safety functions are active (section 5.1.8)
- The indoor climate is controlled according to: room temperature, outdoor temperature, relative humidity, CO<sub>2</sub> content, rain, wind and lux

To achieve the situation described in example 5, the parameter changes described in example 11.3 must be performed independently of the selected sun screen strategy. However, the sun screen must be activated and it must be decided whether a presence signal is to be used.



In addition to the sensors/functions that are already activated in connection with ventilation and heating control, the “Blinds control” must be set to “On”.

If you wish to use the presence signal to control the sun screen, set the “PIR sensor” to “On”.

### 11.5.1 General settings for sun screening

There are both general parameter settings and strategy-dependent parameter settings to be configured when using sun screen. The strategy-dependent settings are explained in detail in the relevant examples.

#### Choice of control strategy and general sun screen settings



The strategy for sun screen must be selected. See section 9.2 for an explanation of strategies.

The safety settings must be adjusted regardless of the control strategy selected.



The control modes in the different operating modes must be selected.

If the sun screen is to be deployed at night, set “Screen due to night” to “On” in the required groups.

If “Screen due to night” or “PIR sensor” is activated, this must be specified further by clicking on “More”.

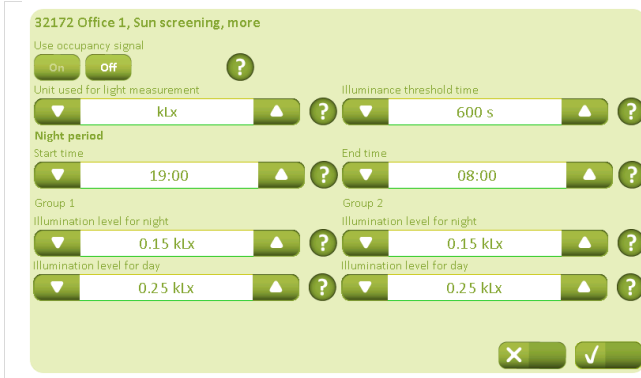

If a PIR sensor is used, "Use occupancy signal" must be set to "On".

If "Screen due to night" is required, night is defined by using either light levels or time intervals.

The "Unit for light measurement" must be set to the same unit used by the light meter.

It is recommended that "Illuminance threshold time" is not set too low e.g. 600 seconds, as this can result in cyclic variation of the sun screen.



Click on "More" to configure strategy dependent parameters.

For an explanation of the strategy-dependent parameters, go to the respective detailed example.

### Configuring the safety parameters

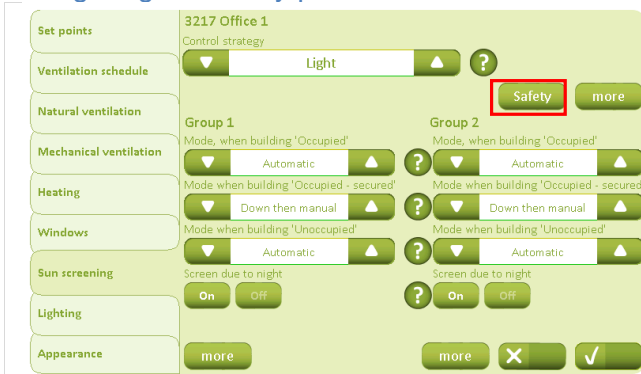

The safety settings remain as specified and are not changed, even if the management strategy is subsequently changed.

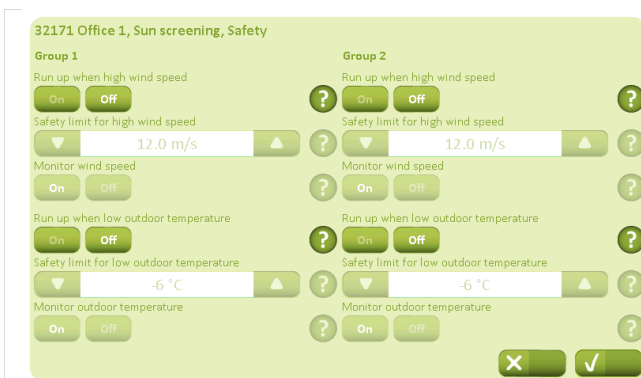

For the protection of the sun screening product, it is recommended that the sun screening product is withdrawn in the event of either high winds or low temperature.



### 11.5.2 Example #5-1 Sun screening - light strategy

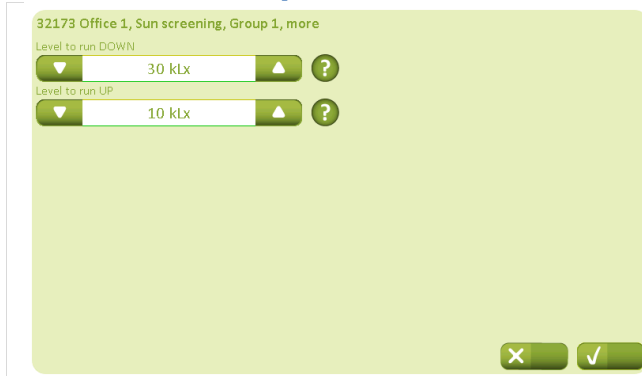

The light levels for deployment and withdrawal of sun screening product respectively must be configured. In order to avoid cyclical variation of the sun screen product, it is recommended that the values should not be too close together.

### 11.5.3 Example #5-2 Sun screening - energy strategy

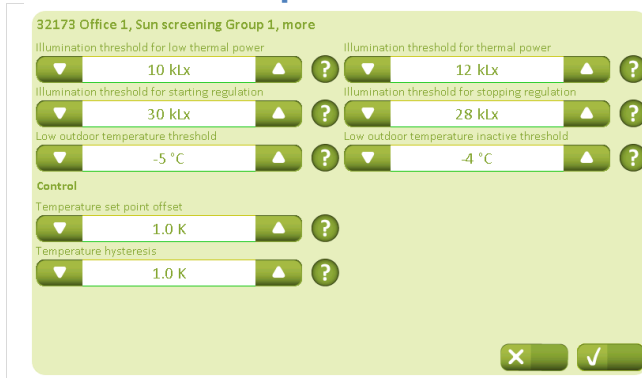

Temperature and illumination set-points must be defined based on when they contribute positively or negatively to the building's room temperature.

Note that "Low outdoor temperature threshold" should not be below the "Safety limit for low outdoor temperature", or it will be overridden (section 9.1).

In order to avoid cyclical variation of the sun screening product, it is recommended that the set-points should not be configured too low for "Temperature set-point offset" and "Temperature hysteresis" respectively.

### 11.5.4 Example #5-3 Sun screening - energy including slat strategy

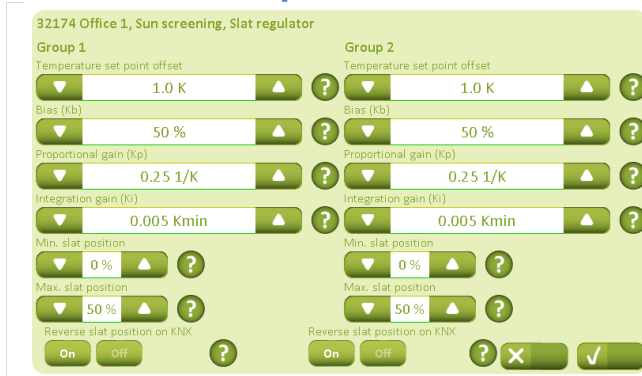

The position of the slats in the different operating modes must be configured.

0% = vertical slats  
50% = horizontal slats

Temperature and illumination set-points must be defined based on when they contribute positively or negatively to the building's room temperature.

Note that "Low outdoor temperature threshold" should not be below the "Safety limit for low outdoor temperature", or it will be overridden (section 9.1).



The tilting of the slats must be configured. The tilting is based on temperature measurements in the room.

## 12 Factory settings

The below tables show the NV Comfort™ factory settings. In the tables it is possible to record new settings. Values are only shown, if at least one room has been activated.

### 12.1 Factory settings – basic settings (green screens)

#### 12.1.1 General settings

| Screen shot                                     | Parameter                                | Factory setting    | New setting |
|---|--|--------------------|-------------|
| <b>General 311 – Building</b>                   |  |                    |             |
|   | Name on the building tab                 | Building           |             |
|   | Name on the rooms tab                    | Rooms              |             |
|   | Repositioning interval for ventilation   | 10 min.            |             |
|   | Repositioning interval for sun screening | 30 min.            |             |
|   | Time limit for missing measured values   | 20 min.            |             |
|   | Time constant, fast wind speed           | 0 s                |             |
|   | Time constant, slow wind speed           | 0 min              |             |
| <b>Secured period 312 – Building</b>            |  |                    |             |
|   | Week days                                | All                |             |
|   | Start time                               | 16:00              |             |
|   | End time                                 | 08:00              |             |
|   | Week days                                | None               |             |
|   | Start time                               | 16:00              |             |
|   | End time                                 | 08:00              |             |
|   | Action when the period starts            | Occupied – Secured |             |
|   | Action when the period ends              | Nothing            |             |
|   | Enforce secure period                    | Off                |             |
| <b>Sun screening Safety 313 – Building</b>      |  |                    |             |
|   | Run up at high wind speed                | Off                |             |
|   | Safety limit for high wind speed         | 12,0 m/s           |             |
|   | Monitor wind speed                       | On                 |             |
|   | Run up at low outdoor temperature        | Off                |             |
|   | Safety limit for low outdoor temperature | 3 °C               |             |
|   | Monitor outdoor temperature              | On                 |             |
| <b>General 331 – System</b>                     |  |                    |             |
|   | Language (when not changed)              | English            |             |
|   | Back light level                         | 80 %               |             |
|   | Standby time out time                    | 5 min.             |             |
|   | Beep                                     | On                 |             |
|   | Turn back light off during standby       | Off                |             |
|   | PIN code for setup                       |                    |             |
|   | PIN code for daily operation             |                    |             |
| <b>General 3311 – System – Network settings</b> |  |                    |             |
|   | Use DHCP                                 | On                 |             |
|   | IP address                               |                    |             |
|   | Subnet mask                              |                    |             |
|   | Default gateway                          |                    |             |
|   | Primary DNS                              |                    |             |
|   | Secondary DNS                            |                    |             |

| Screen shot                | Parameter                | Factory setting | New setting |
|----------------------------|--------------------------|-----------------|-------------|
| Date and time 332 – System |                          |                 |             |
|                            | Time format              | 24-hour         |             |
|                            | Time zone                | UTC +1          |             |
|                            | Year                     |                 |             |
|                            | Month                    |                 |             |
|                            | Day                      |                 |             |
|                            | Time                     |                 |             |
|                            | Use external time signal | Off             |             |

### 12.1.2 Room settings

| Screen shot                                 | Parameter  | Factory setting  | New setting |
|---|--|--|-------------|
| Set points 3211 – Office 1 – Heating period |  |  |             |
|   | Heating temperature set point                      | 22,0 °C  |             |
|   | CO <sub>2</sub> threshold of pulse vent./ventilate | 1200 ppm   |             |
|   | RH threshold of pulse vent./ventilate              | 70%  |             |
|   | Temperature influence                              | 0,2 1/K  |             |
|   | Offset, empty building                             | -1,0 K   |             |
|   | Threshold for low outdoor temperature              | 10,0 °C  |             |
| Set points 3211 – Office 1 – Cooling period |  |  |             |
|   | Base ventilation set point                         | 24,0 °C  |             |
|   | CO <sub>2</sub> Level                              | 1000 ppm   |             |
|   | RH set point                                       | 50 %   |             |
|   | Offset – empty building                            | -1,0 K   |             |
| Set points 32111 – Office 1 – More          |  |  |             |
|   | Min. dead band between heating and ventilation     | 1,0 K  |             |
|   | Temperature offset range                           | 2 K  |             |
|   | Ventilation gain range                             | 200  |             |
|   | Condition for warm outdoor conditions              | None   |             |
|   | Mode during "warm outdoor conditions"              | Closed   |             |
|   | Threshold for high apparent outdoor temperature    | 30,0 °C  |             |
|   | Threshold for high outdoor temp.                   | 35,0 °C  |             |
|   | Temperature difference                             | 2,0 K  |             |
|   | Close manually controlled windows at mode change   | Off  |             |
| Ventilation schedule 3212 – Office 1        |  |  |             |
|   | Week days  | None   |             |
|   | Time   | 07:00, 08:00, 09:00, 10:00, 11:00, 12:00, 13:00, 14:00 |             |
|   | Type   | None, None, None, None, None, None, None, None         |             |
|   | Duration   | 5, 5, 5, 5, 5, 5, 5, 5                                 |             |
|   | Seasons  |  |             |
| Ventilation schedule 32121 – Office 1       |  |  |             |
|   | Time   | 07:00, 08:00, 09:00, 10:00, 11:00, 12:00, 13:00, 14:00 |             |
|   | Type   | None, None, None, None, None, None, None, None         |             |
|   | Duration   | 5, 5, 5, 5, 5, 5, 5, 5                                 |             |
|   | Seasons  |  |             |
|   | Duration of the manual ventilation                 | 5 min.   |             |

| Screen shot                                 | Parameter   | Factory setting | New setting |
|---|---|-----------------|-------------|
| Natural ventilation 3213 – Office 1         |   |                 |             |
|   | Enable temperature controlled ventilation                           | On              |             |
|   | CO <sub>2</sub> influence   | 0,0050 K/ppm    |             |
|   | Min. ventilation set point  | 21,0 °C         |             |
|   | RH influence  | 0,02 K/%        |             |
|   | Enable pulse ventilation during winter                              | On              |             |
|   | Min. duration of a pulse ventilation                                | 30 s            |             |
|   | Min. interval between two pulses                                    | 30 min.         |             |
|   | Max. Duration of a pulse ventilation                                | 180 s           |             |
|   | Max. Interval between two pulses                                    | 60 min.         |             |
| Natural ventilation 32131 – Office 1 – More |   |                 |             |
|   | Proportional gain   | 20 %/K          |             |
|   | Max. Allowed temperature drop                                       | 1,0 K           |             |
|   | Wind reduction set point  | 1,0 m/s         |             |
|   | Threshold for low room temperature                                  | 17,0 °C         |             |
|   | Close hand controlled windows at low room temperature               | On              |             |
|   | Differential gain   | 5 %/Ks          |             |
| Fan 3214 – Office 1 – Heating period        |   |                 |             |
|   | Temperature offset for start  | 2,0 K           |             |
|   | Temperature gain  | 50 %/K          |             |
|   | CO <sub>2</sub> level for start                                     | 1200 ppm        |             |
|   | CO <sub>2</sub> level for full output                               | 2000 ppm        |             |
|   | RH level start  | 60 %            |             |
|   | RH level for full output  | 100 %           |             |
| Fan 3214 – Office 1 – Cooling period        |   |                 |             |
|   | Temperature offset for start  | 2,0 K           |             |
|   | Temperature gain  | 50 %/K          |             |
|   | CO <sub>2</sub> level for start                                     | 1200 ppm        |             |
|   | CO <sub>2</sub> level for full output                               | 2000 ppm        |             |
|   | RH level start  | 60 %            |             |
|   | RH level for full output  | 100 %           |             |
| Fan 32141 – Office 1 – More                 |   |                 |             |
|   | Output threshold for On   | 0 %             |             |
|   | Allow mechanical ventilation during winter                          | On              |             |
|   | Allow mechanical ventilation running when the room is unoccupied    | On              |             |
|   | Allow mechanical ventilation to run when the building is unoccupied | On              |             |
|   | Only use mechanical ventilation during warm outdoor conditions      | Off             |             |
|   | Fan type  | Assisting fan   |             |
|   | Air supply temperature gain   | -2,0            |             |
|   | Output threshold for on   | 0 %             |             |
|   | Min. air supply temperature set point                               | 18,0 °C         |             |
| Heating 3215 – Office 1                     |   |                 |             |
|   | Proportional gain (Kp)  | 10 %/K          |             |
|   | Integrations gain (Ki)  | 1,0 %/Ks        |             |
|   | PWM time base   | 0 min.          |             |
| Windows 3216 – Office 1 – Window group 1    |   |                 |             |
|   | Max. position "Building unoccupied"                                 | 0 %             |             |
|   | Max. position "Building occupied, secured"                          | 50 %            |             |
|   | Max. position "Building occupied"                                   | 100 %           |             |
|   | Max. position, rain   | 0 %             |             |
|   | Wind threshold for closing windows, raining                         | 4 m/s           |             |

|   |   |                  |             |
|---|---|------------------|-------------|
|   | Wind threshold – close windows              | 8 m/s            |             |
| Screen shot                                       | Parameter                                   | Factory setting  | New setting |
| Windows 3216 – Office 1 – Window groups 2         |   |                  |             |
|   | Max. position "Building unoccupied"         | 0 %              |             |
|   | Max. position "Building occupied, secured"  | 50 %             |             |
|   | Max. position "Building occupied"           | 100 %            |             |
|   | Max. position, rain                         | 0 %              |             |
|   | Wind threshold for closing windows, raining | 4 m/s            |             |
|   | Wind threshold – close windows              | 8 m/s            |             |
| Windows 32161 – Office 1 – Window group 1 – More  |   |                  |             |
|   | Max. position, safety                       | 0 %              |             |
|   | Window size                                 | Normal           |             |
|   | Initial opening                             | 10 %             |             |
|   | Opening amplification                       | 100 %            |             |
|   | Closing amplification                       | 100 %            |             |
| Windows 32161 – Office 1 – Window group 2 – More  |   |                  |             |
|   | Max. position, safety                       | 0 %              |             |
|   | Window size                                 | Normal           |             |
|   | Initial opening                             | 10 %             |             |
|   | Opening amplification                       | 100 %            |             |
|   | Closing amplification                       | 100 %            |             |
| Sun screening 3217 – Office 1                     |   |                  |             |
|   | Control strategy                            | Light            |             |
| Sun screening 32171 – Office 1 – Safety – Group 1 |   |                  |             |
|   | Run up at high wind speed                   | Off              |             |
|   | Safety limit for high wind speed            | 12 m/s           |             |
|   | Monitor wind speed                          | On               |             |
|   | Run up at low outdoor temperature           | Off              |             |
|   | Safety limit for low outdoor temperature    | -6 °C            |             |
|   | Monitor outdoor temperature                 | On               |             |
| Sun screening 32171 – Office 1 – Safety – Group 2 |   |                  |             |
|   | Run up at high wind speed                   | Off              |             |
|   | Safety limit for high wind speed            | 12 m/s           |             |
|   | Monitor wind speed                          | On               |             |
|   | Run up at low outdoor temperature           | Off              |             |
|   | Safety limit for low outdoor temperature    | -6 °C            |             |
|   | Monitor outdoor temperature                 | On               |             |
| Sun screening 32172 – Office 1 – More             |   |                  |             |
|   | Use occupancy signal                        | Off              |             |
|   | Unit used for light measurement             | kLx              |             |
|   | Illuminance threshold time                  | 600 s            |             |
|   | Start time                                  | 19:00            |             |
|   | End time                                    | 08:00            |             |
| Sun screening 32172 – Office 1 – More – Group 1   |   |                  |             |
|   | Illumination level for night                | 0.15 kLx         |             |
|   | Illumination level for day                  | 0.25 kLx         |             |
| Sun screening 32172 – Office 1 – More – Group 2   |   |                  |             |
|   | Illumination level for night                | 0.15 kLx         |             |
|   | Illumination level for day                  | 0.25 kLx         |             |
| Sun screening 3217 – Office 1 – Group 1           |   |                  |             |
|   | Mode, when building "Occupied"              | Automatic        |             |
|   | Mode, when building "Occupied – secured"    | Down then manual |             |
|   | Mode, when building "Unoccupied"            | Automatic        |             |
|   | Screen due to night                         | On               |             |

| Screen shot  | Parameter                                      | Factory setting  | New setting |
|--|--|------------------|-------------|
| Sun screening 3217 – Office 1 – Group 2  |  |                  |             |
|  | Mode, when building "Occupied"                 | Automatic        |             |
|  | Mode, when building "Occupied – secured"       | Down then manual |             |
|  | Mode, when building "Unoccupied"               | Automatic        |             |
|  | Screen due to night                            | On               |             |
| Sun screening 3217 – Office 1 – Group 1 – More (light strategy)                                |  |                  |             |
|  | Level to run DOWN                              | 30 kLx           |             |
|  | Level to run UP                                | 10 kLx           |             |
| Sun screening 3217 – Office 1 – Group 2 – More (light strategy)                                |  |                  |             |
|  | Level to run DOWN                              | 30 kLx           |             |
|  | Level to run UP                                | 10 kLx           |             |
| Sun screening 32173 – Office 1 – Group 1 – More (Energy strategy)                              |  |                  |             |
|  | Illumination threshold for low thermal power   | 10 kLx           |             |
|  | Illumination threshold for starting regulation | 30 kLx           |             |
|  | Low outdoor temperature threshold              | -5 °C            |             |
|  | Illumination threshold for thermal power       | 12 kLx           |             |
|  | Illumination threshold for stopping regulation | 28 kLx           |             |
|  | Low outdoor temperature inactive threshold     | -4 °C            |             |
|  | Temperature set point offset                   | 1,0 K            |             |
|  | Temperature hysteresis                         | 1,0 K            |             |
| Sun screening 32173 – Office 1 – Group 2 – More (Energy strategy)                              |  |                  |             |
|  | Illumination threshold for low thermal power   | 10 kLx           |             |
|  | Illumination threshold for starting regulation | 30 kLx           |             |
|  | Low outdoor temperature threshold              | -5 °C            |             |
|  | Illumination threshold for thermal power       | 12 kLx           |             |
|  | Illumination threshold for stopping regulation | 28 kLx           |             |
|  | Low outdoor temperature inactive threshold     | -4 °C            |             |
|  | Temperature set point offset                   | 1,0 K            |             |
|  | Temperature hysteresis                         | 1,0 K            |             |
| Sun screening 32173 – Office 1 – Group 1 – More (Energy incl. slats strategy)                  |  |                  |             |
|  | Slat position, down, "Occupied – secured"      | 0 %              |             |
|  | Slat position, down, "Occupied"                | 50 %             |             |
|  | Slat position, down, "Unoccupied"              | 0 %              |             |
|  | Illumination threshold for low thermal power   | 10 kLx           |             |
|  | Illumination threshold for thermal power       | 12 kLx           |             |
|  | Low outdoor temperature threshold              | -5 °C            |             |
|  | Illumination threshold for starting regulation | 30 kLx           |             |
|  | Illumination threshold for stopping regulation | 28 kLx           |             |
|  | Low outdoor temperature inactive threshold     | -4 °C            |             |
| Sun screening 32174 – Office 1 – Group 1 – More – More – Group 1 (Energy incl. slats strategy) |  |                  |             |
|  | Temperature set point offset                   | 1,0 K            |             |
|  | Bias (Kb)                                      | 50 %             |             |
|  | Proportional gain (Kp)                         | 0,25 1/K         |             |

|  |                              |            |  |
|--|------------------------------|------------|--|
|  | Integration gain(Ki)         | 0,005 Kmin |  |
|  | Min. slat position           | 0 %        |  |
|  | Max. slat position           | 50 %       |  |
|  | Reverse slat position on KNX | On         |  |

| Screen shot  | Parameter                                      | Factory setting | New setting |
|--|--|-----------------|-------------|
| Sun screening 32174 – Office 1 – Group 1 – More – More – Group 2 (Energy incl. slats strategy) |  |                 |             |
|  | Temperature set point offset                   | 1,0 K           |             |
|  | Bias (Kb)                                      | 50 %            |             |
|  | Proportional gain (Kp)                         | 0,25 1/K        |             |
|  | Integration gain(Ki)                           | 0,005 Kmin      |             |
|  | Min. slat position                             | 0 %             |             |
|  | Max. slat position                             | 50 %            |             |
|  | Reverse slat position on KNX                   | On              |             |
| Sun screening 32173 – Office 1 – Group 2 – More (Energy incl. slats strategy)                  |  |                 |             |
|  | Slat position, down, "Occupied – secured"      | 0 %             |             |
|  | Slat position, down, "Occupied"                | 50 %            |             |
|  | Slat position, down, "Unoccupied"              | 0 %             |             |
|  | Illumination threshold for low thermal power   | 10 kLx          |             |
|  | Illumination threshold for thermal power       | 12 kLx          |             |
|  | Low outdoor temperature threshold              | -5 °C           |             |
|  | Illumination threshold for starting regulation | 30 kLx          |             |
|  | Illumination threshold for stopping regulation | 28 kLx          |             |
|  | Low outdoor temperature inactive threshold     | -4 °C           |             |
| Sun screening 32174 – Office 1 – Group 2 – More – More – Group 1 (Energy incl. slats strategy) |  |                 |             |
|  | Temperature set point offset                   | 1,0 K           |             |
|  | Bias (Kb)                                      | 50 %            |             |
|  | Proportional gain (Kp)                         | 0,25 1/K        |             |
|  | Integration gain(Ki)                           | 0,005 Kmin      |             |
|  | Min. slat position                             | 0 %             |             |
|  | Max. slat position                             | 50 %            |             |
|  | Reverse slat position on KNX                   | On              |             |
| Sun screening 32174 – Office 1 – Group 2 – More – More – Group 2 (Energy incl. slats strategy) |  |                 |             |
|  | Temperature set point offset                   | 1,0 K           |             |
|  | Bias (Kb)                                      | 50 %            |             |
|  | Proportional gain (Kp)                         | 0,25 1/K        |             |
|  | Integration gain(Ki)                           | 0,005 Kmin      |             |
|  | Min. slat position                             | 0 %             |             |
|  | Max. slat position                             | 50 %            |             |
|  | Reverse slat position on KNX                   | On              |             |
| Lighting 3218 – Office 1   |  |                 |             |
|  | Send off signal                                | On              |             |
|  | Occupancy                                      | 10 min.         |             |
| Appearance 3219 – Office 1   |  |                 |             |
|  | Room active                                    | Off             |             |
|  | Temperature sensor                             | On              |             |
|  | CO <sub>2</sub> sensor                         | On              |             |
|  | RH sensor                                      | On              |             |
|  | PIR sensor                                     | Off             |             |
|  | Fan control                                    | On              |             |
|  | Heating control                                | On              |             |
|  | Window control                                 | On              |             |
|  | Blinds control                                 | Off             |             |
|  | Light control                                  | Off             |             |



| Screen shot                         | Parameter   | Factory setting | New setting |
|-------------------------------------|---|-----------------|-------------|
| Appearance 32191 – Office 1 – Names |   |                 |             |
|                                     | Window group 1 – Bus groups 1 active              | On              |             |
|                                     | Window group 1 – Bus group 1- name                |                 |             |
|                                     | Window group 2 – Bus groups 2 active              | On              |             |
|                                     | Window group 2 – Bus group 2- name                |                 |             |
|                                     | Sun screening group 1 – Bus groups 1 active       | On              |             |
|                                     | Sun screening group 1 – Bus group 1- name         |                 |             |
|                                     | Sun screening 2 – Bus groups 2 active             | On              |             |
|                                     | Sun screening 2 – Bus group 2- name               |                 |             |
| Appearance 32192 - Office 1 – More  |   |                 |             |
|                                     | Illumination sensor A connected                   | On              |             |
|                                     | Clear auto. off when room unoccupied              | Off             |             |
|                                     | Windows manually operated – auto off period       | 30 min.         |             |
|                                     | Sun screening manually operated – auto off period | 120 min.        |             |
|                                     | Bus group 1 active                                | On              |             |
|                                     | Bus group 1 name                                  |                 |             |
|                                     | Illumination sensor B connected                   | On              |             |

## 12.2 Factory settings – end-user level (blue screens)

| Screen shot  | Parameter               | Factory setting | New setting |
|--|-------------------------|-----------------|-------------|
| Rooms – Office 1 – Ventilation – Fan manually operated |                         |                 |             |
|  | Fan manual override     | Off             |             |
|  | Fan output              | 0 %             |             |
| Rooms – Office 1 – Ventilation – Windows manual        |                         |                 |             |
|  | KNX group 1             | Closed          |             |
|  | KNX group 2             | Closed          |             |
| Rooms – Office 1 – Temperature – Heating manual        |                         |                 |             |
|  | Heating manual override | Off             |             |
|  | Heating output          | 0 %             |             |

## 13 Maintenance

The different component which make up a NV Comfort™ system, requires different types of maintenance, see below overview.

In the event that the system is found to be worn, any of its parts are loose, or any unusual circumstances are observed, it is important that these issues are addressed promptly or the lifetime of the system will be affected.

### 13.1 NVC KNX A00, touch screen

The screen itself requires only minimal maintenance, however in order to ensure the screen functions optimally, the following procedures should be observed:

- Visual check
- Screen calibration
- Clean the touch screen with a damp soft cloth and a small quantity of cleaning product

Service intervals: check visually annually. Perform calibration and cleaning when needed.

### 13.2 WMX xxx-n, programmable chain actuator

The actuator itself requires only minimal maintenance, however, in order to ensure that the window and actuator function optimally, the following procedures should be observed:

- Check that all windows open freely along the entire length of the chain
- Lubricate window hinges as necessary. See the window supplier's maintenance instructions.
- Ensure that the chain rolls out along its entire length without problem
- Check for chain-wear
- Clean as necessary
- Where necessary lubricate the chain with "Polylub GLY 791"
- Check that the actuator housing and actuator are correctly mounted
- Tighten mounting screws and bolts where necessary

Service intervals: Check the above annually.

### 13.3 WEC xxM, MotorController

The MotorController itself requires only minimal maintenance, however, in order to ensure that the controller functions optimally, the following procedures should be observed:

- Visual check of the MotorController

Service intervals: Check the above at least once a year.

### 13.4 WEW 02M KNX, complete weather station

The weather station consists of the following components:

- WEI 12M, KNX interface
- WEP 005, power supply. 230VAC/24VDC 0,5A
- WLA 340, wind and rain sensor
- WOT 100, outdoor temperature sensor

It is important that the following procedures are observed as the weather station is a central component of the Natural Ventilation system.

- Clean rain sensor WLA 340 with a damp soft cloth and a small quantity of cleaning product
- Check rain and wind sensor operation

Service intervals: Perform the checks specified above at least four times a year.

### 13.5 **WET 112, temperature/CO<sub>2</sub>/humidity sensor**

The temperature sensor is maintenance free; however, because it is central to ventilation control the following checks should be performed:

- Visual check

Service intervals: Perform visual checks annually.

### 13.6 **WEL 100, lux sensor (outdoor)**

The lux sensor itself requires only minimal maintenance, however in order to ensure the sensor functions optimally, the following procedure should be observed:

- Clean lux sensor with a damp soft cloth and a small quantity of cleaning product

Service intervals: Perform the cleaning at least four times a year.

### 13.7 **WEO 1x0, PIR sensor**

The PIR sensor itself requires only minimal maintenance, however in order to ensure the sensor functions optimally, the following procedure should be observed:

- Visual check

Service intervals: Perform visual checks annually.

### 13.8 **WEK 1x0, keypads**

The keypad itself requires only minimal maintenance, however in order to ensure the sensor functions optimally, the following procedure should be observed:

- Clean keypad with a damp soft cloth and a small quantity of cleaning product

Service intervals: Perform the cleaning when needed.